

# ***Carter***

A Better Built Machine.

## **Owner's Manual**

READ THIS MANUAL CAREFULLY,  
IT CONTAINS IMPORTANT SAFETY INFORMATION.



## **INTERCEPTOR GTR 250/300** **MODEL:2861 - Differential**

This kart is designed for off-road use only  
and does not comply with Federal Motor Vehicle Safety Standards.

**Recommended for Ages 16+**



# FOREWORD

Thank you for purchasing our kart. We hope you will enjoy it. Before you begin operating the kart, please carefully read this Owner's Manual for the Interceptor GTR 250, as it contains important safety and maintenance information. Failure to follow the warnings contained in this manual could result in serious injury or death.

The Interceptor GTR 250 fits the needs of a wide variety of kart users above 16 years old. Beginners should seek instruction from your dealer or qualified instructors before and during initial use of the kart. We also recommend that you practice in a large open area until you become familiar with operations of this kart.

Be sure to follow the recommended maintenance schedule and service your kart accordingly. Preventive maintenance is extremely important to the longevity of your kart. Those who will be servicing this kart should carefully review this manual before performing any repair or services.

All information, illustrations, photographs, and specifications contained in this manual are based on the latest product information, available at the time of publication. Due to improvements, or other changes, there may be some discrepancies in this manual. Therefore, if newer information is needed in the future, please contact the local distributor.

Distributor reserves the right to make production changes at any time, without notice, and without incurring any obligation to make same or similar changes to vehicles previously built or sold.

We hope you will have a pleasant experience with our product. Thanks again for choosing our kart.



**Carter Brothers Manufacturing, Co. , Inc.**  
1871 U.S. Highway 231 South  
Brundidge, Alabama 36010  
Phone: 800-523-5278  
[www.carterbro.com](http://www.carterbro.com)

# INDEX

## Owner's Manual

Warranty	1
About Safety	5
Important Safety Information	6
Safety Labels	8
Are You Ready To Drive?	9
Is Your Vehicle Ready To Drive?	11
Safe Driving Precautions	13
General Informations	15
Specifications	16
Locations Of Parts	18
Operation	20
Periodic Checks And Services	25
Service Instructions	26
Service Information	31
Wiring Diagram	40
Trouble Shooting Charts	41
Set-up Instructions	46

# WARRANTY



*A Better Built Machine*

## CARTER KARTS LIMITED WARRANTY

### REGISTRATION

**ALL UNITS MUST BE REGISTERED WITHIN 10 DAYS OF PURCHASE OR THE WARRANTY IS VOID**

To register your product, complete the Warranty Registration form. Fax or mail the warranty registration form with a copy of the sales receipt to Carter. A warranty registration form MUST be on file with Carter before a warranty claim can be processed.

### WARRANTY PERIOD

*The warranty period starts from the date that the unit is sold to the first retail purchaser for all Carter products. During the warranty coverage period, we will cover warranty parts and labor only. Parts repaired and replaced under this warranty are covered only for the remainder of the kart's warranty.*

### WARRANTY PERIODS FOR ALL KARTS ARE AS FOLLOWS: FRAME FOR 1 YEAR

Void if frame is broken or bent due to abuse.

1. Underside scraped abusively.
2. Wheels are bent or broken due to impact.
3. Spindles are bent due to impact.
4. Paint is worn off of rear bumper, indicating an extra rider.
5. Axles are bent out of ordinary position either horizontally or vertically.
6. Non-factory altering of engine or frame and its components.

If the frame is found to be defective due to material and/or workmanship when inspected at an authorized Carter Service Center. Carter will at its option - repair or replace defective parts to the original purchaser at no charge.

### INTERCEPTOR GTR 250 2R PARTS COVERAGE

Warranty starts from the date of purchase by the first retail purchaser.

- > Engine: 2 year Limited factory warranty. \*
- > A-Arm, Spindles, Axles, Rack & Pinion: 90 days
- > Electronics, Carburetor & Muffler: 90 days
- > Battery: 30 days
- > Radiator: 90 days
- > CVT: 60 days

# WARRANTY

---

\* The second year of the engine warranty is for the FUNCTION of certain engine parts. Function is described as warranty coverage for parts that are not normally exposed to misuse, abuse, or extreme wear. These engine parts are warranted to be free of manufacturing flaws such as stress cracks, inferior material (metal), casting flaws, and machining flaws. Upon part failure, only Carter Brothers Manufacturing, Inc. may determine if it is covered. Any failure or damage to a part that does not influence its function will not be covered. Normal wear of these parts is not covered. Parts covered under the second year period would include, but not necessarily be limited to:

- Head cover
- Cylinder, and Cylinder Head
- Left Case Cover
- Left Crankcase
- Right Case Cover
- Right Crankcase
- Mission Case
- Cylinder Head Side Cover
- Certain Internal Engine Parts
- Certain Bearings and Gears

## PARTS NOT COVERED

This warranty does not cover consumable wear and tear items such as, but not limited to:

- Throttle cable
- Brake cable
- Chains
- Seats
- Fasteners
- Air Filters
- Brake pads
- Tires
- Oil changes
- Problem occurring due lack of proper maintenance
- Problem occurring due to abuse

Modifications to your GTR 250 that are not Carter approved will void the warranty.

Defective parts are subject to recall by Carter upon failure, and are required to be held by the dealer or service center until the warranty claim is settled.

## WARRANTY COVERAGE

Carter Brothers Manufacturing, Inc. will repair or replace, at its option, any part that is found defective in material or factory workmanship under normal use.

Parts used in the “repair or replace” process under this warranty are covered only for the remainder of the GTR warranty.

## TO QUALIFY FOR THIS WARRANTY:

- The GTR must be purchased from a dealer who is an authorized Carter dealer, and
- Prior to delivery to the purchaser, set-up and pre-delivery service must be performed by a dealer who is an authorized Carter dealer.
- All units must be registered WITHIN 10 DAYS OF PURCHASE or the warranty is void.
- All warranty work must be performed by an authorized Carter dealer or service center.

# WARRANTY

---

## **OWNER'S WARRANTY RESPONSIBILITIES**

As the kart owner, you are responsible for presenting your kart to the dealer or service centre as soon as a problem exists.

All shipping and transportation charges for any items returned for warranty evaluation and/or replacement are to be provided by the kart owner. Costs from kart owner to dealer or service center are the kart owner's responsibility.

## **IMPORTANT NOTICE:**

**We do not charge for parts for authorized warranty repairs. Any defective parts from repairs are required to be returned to Carter upon request. All warranties are voided if the vehicle has been altered for use in racing or competition, rented, used under abnormal conditions, or subject to abuse, misuse, neglect or improper maintenance. Carter is not liable for any damage claim or liability claim, personal or otherwise, resulting from operation of this vehicle in any way. Carter reserves the right to change product specifications, designs, and standard equipment without notice and without incurring obligation. These vehicles are not designed or manufactured for racing or use on rental tracks, public streets, public roads, highways, paved surfaces, or right-of-ways. Always wear an approved helmet and eye protection when riding. Always secure loose clothing and long hair. Always wear seatbelts. Read the operations manual.**



# CUSTOMER SAFETY INFORMATION AND WARRANTY REGISTRATION FORM INTERCEPTOR GTR 250

**Warranty registration must be filed with Carter Brothers Manufacturing within 10 days of purchase or warranty will be void.**

In order to validate the warranty, purchaser agrees and promises to hold Carter Brothers Manufacturing and the Dealer harmless and indemnify them from all claims and demands or causes of action which may arise or be asserted against them arising or allegedly arising from any claim related to the delivery of the Vehicle or its use by the Purchaser or any third parties, including all attorney fees and legal costs whether or not any claim or assertion is deemed or found to be valid or not. All parties agree and stipulate that any legal proceedings, which relate to or arise out of this transaction, shall be brought only in a federal or state court located in the County of Pike, State of Alabama.

This form and Owner's Manual contains vital safety information. Carter Brothers Manufacturing asks that you review the warnings and verify that you have read and understood each warning by placing your initials on the line beside it.

**I understand that I must:** (please initial beside each number)

- \_\_\_\_\_ **1. Read the Owner's Manual carefully**, follow the operating procedures described in the Owner's Manual and pay special attention to the warnings contained in the manual and on all labels.
- \_\_\_\_\_ **2. It Is Recommended** that no one under the age of 16 operate the Vehicle.
- \_\_\_\_\_ **3. Never** allow any operation of the Vehicle before reading the Owner's Manual.
- \_\_\_\_\_ **4. Never** allow more than one operator and one passenger to ride on the Vehicle.
- \_\_\_\_\_ **5. Never** operate the Vehicle after consuming alcohol or drugs.
- \_\_\_\_\_ **6. Never** operate the Vehicle without wearing your seat belt (Karts only), a proper helmet, eye protection, and protective clothing.
- \_\_\_\_\_ **7. Never** operate the Vehicle on unsafe terrain or at excessive speeds.
- \_\_\_\_\_ **8. Never** do wheelies, jumps, or other stunts.
- \_\_\_\_\_ **9. Never** allow anyone to ride on the back or the front of the Kart or the handlebars of the Scooter.
- \_\_\_\_\_ **10. Never** allow the Kart to be driven on a public road of any kind, even a dirt or gravel one because you may not be able to avoid colliding with other vehicles. Operating your Kart on a public road may be against the law.
- \_\_\_\_\_ **11. Never** operate the Kart on pavement. The Kart is not designed to be used on paved surfaces and may be difficult to control.
- \_\_\_\_\_ **12. Always follow the break-in period** as described in the Owner's Manual or your engine warranty will be voided.
- \_\_\_\_\_ **13. Always clean the air filter** as described in the Owner's Manual or your engine warranty will be voided.
- \_\_\_\_\_ **14. Never** operate the Kart at night. The attached lights are for ornamental purposes only. They will not provide sufficient lighting for night time operation.

In signing this document, the Purchaser acknowledges and agrees that he has read the Owner's Manual and that failure to do so voids all warranties, both implied and expressed.

**I certify that I understand all of the above warnings, warnings in the Owner's Manual, and that failure to obey these warnings could result in death or severe injury.**

Date of Purchase(mm/dd/yy)		Model Number	VIN Number
First Name	MI	Last Name	e-mail
Street Address			
City	State	Zip Code	
Dealer Name		Website Address	
City	State	Zip Code	
Home Telephone Number		Purchaser Signature	

**Please fill out this form and fax or mail it back to :Carter Brother Manufacturing**

Carter Brothers Manufacturing | 1871 U.S.Hwy.231 | Brundidge, AL.36010 | Ph:800-523-5278 Fax:334-735-3500 |

Web: [www.carterbro.com](http://www.carterbro.com)

C-GTR-WR-US-03-2007



# ABOUT SAFETY

---

In order to keep everyone safe, you must take responsibility for the safe operation of your kart.

To help you make informed decisions about safety, we have provided operating procedures and other information on labels and in this manual. This information alerts you to potential hazards that could hurt you or others.

It is not practical or possible to warn you about all the hazards associated with operating or maintaining a kart. You must use your own good judgment.

You will find important safety information in a variety of forms, including:

**Safety Labels** – On the kart.

**Safety Messages** – Preceded by a safety alert symbol  and one of two signal words: WARNING, or CAUTION.

**These signal word mean:**



Physical harm may result from failure to adhere to the instructions that are described within the WARNING labels.

**Safety Headings** — such as important safety reminders or important safety precautions.

**Safety Section** — such as kart safety.

**Instructions** — how to use this kart correctly and safely.

This entire manual is filled with important safety information—please read it carefully.

# IMPORTANT SAFETY INFORMATION

---

Your kart will provide you with many years of service and pleasure, providing you take responsibility for your own safety and understand the challenges you may meet while driving.

There is much that you can do to protect yourself while operating your kart. You'll find many helpful recommendations throughout this manual. The following are a few that we consider most important.

## **Follow the Age Recommendation**

Experienced adult supervision should be present for all inexperienced operators.

## **Always Wear a Helmet**

It's a proven fact: wearing helmets significantly reduces the number and severity of head injuries. Always wear an approved motorcycle helmet. We also recommend that you wear eye protection, sturdy boots, gloves, and other protective gear.

## **Drive Off-Road Only**

Your kart is designed and manufactured for off-road use only. Its tires are not made for pavement, and the kart does not have features required for use on public roads. If you need to cross a paved or public road, shut the kart's power off, get off and walk your kart across.

## **Take Time to Learn & Practice**

Even if you have driven other karts, take time to become familiar with how this kart works and handles. Practice in a safe area until you build your skills and get accustomed to this kart's size and weight.

Because many accidents involve inexperienced or untrained drivers, we urge all drivers to take a training course approved by the Go-Kart Safety Institute. Check with your dealer for more information on training courses.

## **Be Alert for Off-Road Hazards**

The terrain can present a variety of challenges when you drive off-road. Continually "read" the terrain for unexpected turns, drop-offs, rocks, ruts, and other hazards. Always keep your speed low enough to allow time to see and react to hazards.

# IMPORTANT SAFETY INFORMATION

---

## **Drive within Your Limits**

Pushing limits is another major cause of kart accidents. Never drive beyond your personal abilities or faster than conditions warrant. Remember that alcohol, drugs, fatigue, and inattention can significantly reduce your ability to make good judgments and drive safely.

## **Alcohol, Drugs, and Driving**

Alcohol, drugs, and driving don't mix. Even one drink can reduce your ability to respond to changing conditions, and your reaction time gets worse with every additional drink. So don't drink and drive, and don't let your friends drink and drive either. Do not operate this kart if you are taking any prescriptions.

## **Do Not Operate this Kart at Night**

Lower visibility at night can greatly reduce a driver's judgment. Driving at night is dangerous and will increase the possibility of an accident.

## **Never Run Your Kart Indoors**

The exhaust from the engine contains carbon monoxide, a poisonous gas which is tasteless & odorless. Carbon monoxide kills.

## **Keep Away from Moving Parts of the Kart**

Never place your hands or any other body part near any moving part of the kart. Failure to adhere to this warning may cause physical harm to your body.

## **Skidding or Sliding**

The terrain's surface can be a major factor affecting turns. Skidding in a turn is more likely to occur on slippery surfaces such as snow, ice, mud, and loose gravel. If you skid on ice, you may lose all directional control. To avoid skidding on slippery terrain, keep your speed low and drive carefully.

# SAFETY LABELS

This section presents some of the most important information and recommendations to help you drive your kart safely. Please take a few moments to read these pages.

The labels should be considered permanent parts of the kart. If a label comes off or becomes hard to read, contact your dealer for warning label replacements.

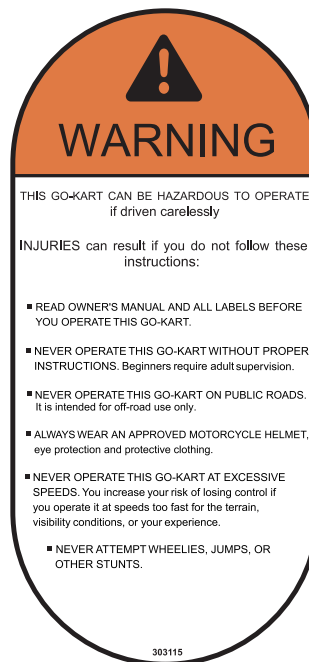
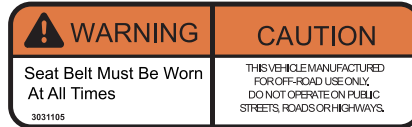

# ARE YOU READY TO DRIVE ?

---

Before each drive, make sure you and your kart are both ready to drive. This section discusses how to evaluate your driving readiness, what items you should check on your kart, and adjustments to make for your comfort, convenience, or safety.

Before you drive your kart for the first time, we urge you to:

- Read this owner's manual and the labels on your kart carefully.
- Make sure you understand all the safety messages.
- Know how to operate all the controls.
- Have an experienced adult present if operator is not experienced in this kart.

Before each drive, be sure:

- You wear your seat belt at all times while driving your kart.
- You feel well and are in good physical and mental condition.
- You are wearing an approved motorcycle helmet (with chin strap tightened securely), eye protection, and other protective clothing.
- You don't have any alcohol or drugs in your system.

## Protective Apparel

For your safety, we strongly recommend that you always wear an approved motorcycle helmet, eye protection, boots, gloves, long pants, and long-sleeved shirt or jacket, whenever you drive. Although complete protection is not possible, wearing proper gear can reduce the chance of injury when you drive.

The following suggestions will help you choose the proper driving gear.

## Helmets and Eye Protection

Your helmet is your most important piece of driving gear because it offers the best protection against head injuries. A helmet should fit your head comfortably and securely.

An open-face helmet offers some protection, but a full-face helmet offers more. Regardless of the style, look for a DOT (Department of Transportation) sticker on any helmet you buy. Always wear a face shield or goggles to protect your eyes and help your vision.



### WARNING

**Operating this go-kart without wearing an approved motorcycle helmet, eye protection, and protective clothing could increase your chances of head and/or eye injury, and the possibility of death in the event of a severe accident.**

**Always wear an approved motorcycle helmet that fits properly and wear eye protection (goggles or face shield), gloves, boots, long-sleeved shirt or jacket and long pants.**

# ARE YOU READY TO DRIVE?

---

## Additional Driving Gear

In addition to a helmet and eye protection, we also recommend:

- Sturdy off-road motorcycle boots to help protect your feet, ankles, and lower legs.
- Off-road motorcycle gloves to help protect your hands.
- Driving pants with knee and hip pads, a driving jersey with padded elbows, and a chest/shoulder protector.

## Driver Training

Developing your driving skills is an ongoing process. Even if you have driven other karts, before driving take time to become familiar with how this kart works and handles. Practice driving the kart in a safe area to build your skills. Do not drive in rough terrain until you get accustomed to the kart's controls, and feel comfortable with its size and weight.



### WARNING

**Operating this kart without your seat belt could cause you to be thrown from the kart, causing serious injury or death.**

## Age Recommendation

It is strongly recommended that no one under the age of 16 be permitted to operate this go-kart.



### WARNING

**A child driving a kart that is not recommended because he/she could lose control of the kart resulting in severe injury or death.**

## No Alcohol or Drugs

Alcohol, drugs, and karts don't mix. Even a small amount of alcohol can impair your ability to operate a kart safely. Likewise, drugs—even if prescribed by a physician—can be dangerous while operating a kart. Consult your doctor to be sure it is safe to operate a vehicle after taking medication.



### WARNING

**Operating this kart after consuming alcohol or drugs can seriously affect your judgment, cause you to react more slowly, affect your balance and perception, and could result in serious injury or death.  
Never consume alcohol or drugs before or while operating this kart.**

# IS YOUR VEHICLE READY TO DRIVE?

Before each drive, it is important to inspect your kart and make sure any problems you find are corrected. A pre-drive inspection is a must, not only for safety, but because having a breakdown, or even a flat tire, can be a major inconvenience.

If your kart has overturned or has been involved in a collision, do not drive it until your kart has been inspected by your dealer. There may be damages or other problems you cannot see.



## WARNING

**Improperly maintaining this kart or failing to correct a problem before driving may cause a crash in which you can be seriously hurt or killed. Always perform a pre-drive inspection before every drive and correct any problems.**

### Pre-drive Inspection

Check the following items before you get on the kart:

#### ■ Engine Oil

Check the level and add oil if needed. Check for leaks.

#### ■ Fuel

Check the level and add fuel if needed. Also make sure the fuel fill cap is securely fastened. Check for leaks.

#### ■ Tires

Use a gauge to check the air pressure. Adjust if needed. Also look for signs of damage or excessive wear.

#### ■ Nuts & Bolts

Check the wheels to see that the axle nuts are tight. Use a wrench to make sure all accessible nuts, bolts, and fasteners are tight.

#### ■ Underbody & Exhaust System

Check for and remove any dirt, vegetation or other debris that could be a fire hazard or interfere with the proper operation of the kart.

#### ■ Air Cleaner Housing Drain Tube

Check for deposits in the drain tube. If necessary, clean the tube and check the air cleaner housing.

# IS YOUR VEHICLE READY TO DRIVE?

---

- Leaks, Loose Parts

Walk around your kart and look for anything that appears unusual, such as a leak or loose cable.

- Lights

Make sure the headlights, brake light, and tail light are working properly.

- Throttle

Check the freeplay and adjust if needed. Press the throttle to make sure it moves smoothly without sticking, and snaps back automatically when it is released.

- Brakes

Press the brake pedal several times, check for proper brake pedal freeplay. Make sure there is no brake fluid leakage.

- Engine Stop Button

While engine is running, press and hold the engine stop button for two seconds. Make sure engine stops.

- Steering Wheel

Check that the wheels turn properly as you turn the steering wheel.

- Cable

Check all cable housings for wear. Check the fittings for looseness. Replace or tighten as needed.



# SAFE DRIVING PRECAUTIONS

---

## Off-Road Use Only

Your kart and its tires are designed and manufactured for off-road use only, not for pavement. Driving on pavement can affect handling and control. You should not drive your kart on pavement.



### WARNING

**Operating this kart on paved surfaces may seriously affect handling and control of the kart, and may cause the vehicle to go out of control.**

**Never operate the kart on any paved surfaces, including sidewalks, driveways, parking lots and streets.**

When driving off-road, also remember to always obey local off-road driving laws and regulations. Obtain permission to drive on private property. Avoid posted areas and obey "no trespassing" signs.

You should never drive your kart on public streets, roads or highways, even if they are not paved. Drivers of street vehicles may have difficulty seeing and avoiding you, which could lead to a collision. In many states it is illegal to operate karts on public streets, roads and highways.



### WARNING

**Operating this kart on public streets, roads or highways could cause a collision with another vehicle.**

**Never operate this go-kart on any public streets, roads or highways, whether dirt, gravel or pavement.**

## Keep Hands and Feet on Controls

When driving your kart, always keep both hands on the steering wheel and both feet on the foot controls. Removing hands or feet away from the controls can result in loss of balance and reduce your ability to react and control the kart.



### WARNING

**Removing hands from steering wheel or feet from foot controls during operation can reduce your ability to control the kart or could cause you to lose your balance and fall off the kart.**

**Always keep both hands on the steering wheel and both feet on the foot controls of your kart during operation.**

# SAFE DRIVING PRECAUTIONS

## Control Speed

Driving at excessive speeds increases the chance of an accident. In choosing a proper speed, you need to consider the capability of your kart, the terrain, visibility and other operating conditions, plus your own skills and experience.

### WARNING

**Operating this kart at excessive speeds increases your chances of losing control of the kart, which can result in an accident.**

**Always drive at a speed that is proper for your kart, the terrain, visibility and other operating conditions, and your experience.**

## Use Care on Unfamiliar or Rough Terrain

Before driving in a new area, always check the terrain thoroughly. Don't drive fast on unfamiliar terrain or when visibility is limited (it's sometimes difficult to see obstructions like hidden rocks, bumps, or holes in time to react.)

### WARNING

**Failure to use extra care when operating this kart on unfamiliar terrain could result in the kart overturning or going out of control.**

**Go slowly and be extra careful when operating on unfamiliar terrain. Always be alert to changing terrain conditions when operating the kart.**

Never drive past the limit of visibility. Maintain a safe distance between your kart and other off-road vehicles. Always exercise caution and use extra care on rough, slippery and loose terrain.

### WARNING

**Failure to use extra care when operating on excessively rough, slippery or loose terrain could cause loss of traction or vehicle control, which could result in an accident, including an overturn.**

**Do not operate on excessively rough, slippery, or loose terrain until you have learned and practiced the skills necessary to control the kart on such terrain. Always be especially cautious on these kinds of terrain.**

## Do Not Perform Stunts

You should always operate your kart in a safe and reasonable manner. When driving, always keep all four wheels on the ground.

### WARNING

**Attempting wheelies, jumps, and other stunts increases the chance of an accident, including an overturn.**

**Never attempt stunts, such as wheelies or jumps. Don't try to show off.**

# GENERAL INFORMATION

## MODEL IDENTIFICATION

### FRAME NUMBER

The frame number or VIN is stamped on the upper firewall of the frame behind the seat.

### ENGINE NUMBER

The engine number is located on the lower front left side of the engine case.

### FUEL RECOMMENDATIONS

Be sure to use the specified fuel.

#### FUEL

Gasoline should be 92 octane or higher.  
Unleaded gasoline is recommended.  
Engine oil should be SAE 10W-30.

VIN NUMBER LOCATION



### BREAK-IN PROCEDURE

For the first 2 hours of riding, do not exceed 2/3 throttle.

Vary Engine speed for the first 5 hours.

Never hold engine at full throttle for long periods of time.

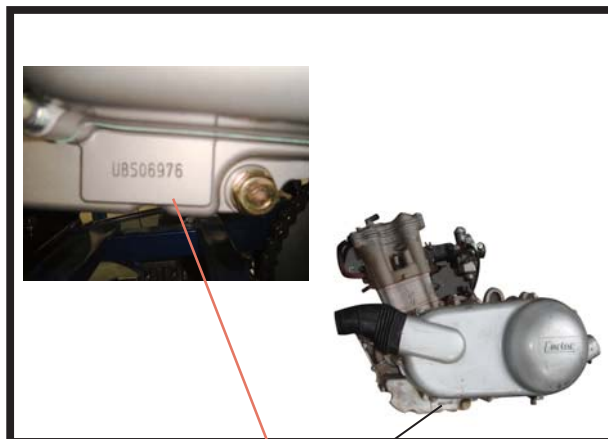

VIN NUMBER LOCATION

# SPECIFICATIONS

## DIMENSIONS

Overall Length -----	92 in. (2340mm)
Overall Width -----	64 in. (1620mm)
Overall Height -----	61 in. (1541mm)
Wheelbase -----	68 in. (1727mm)
Front Track -----	47.1 in. (1060mm)
Rear Track -----	39.4 in. (1000mm)
Ground Clearance -----	8 in. (205mm)

## ENGINE

Type -----	4-Stroke
Engine Capacity -----	250cc
Bore / Stroke -----	71mm / 63mm
Displacement -----	294.4cc
Corrected Compression Ratio -----	10.5:1
Carburetor -----	22mm
Output Power -----	13.2kw/7000rpm
Maximum Torque -----	20.6Nm/5500rpm
Starting -----	Electric
Ignition -----	C.D.I.
Lubrication -----	Force & Splash
Transmission -----	Automatic (C.V.T system)
Spark Plug -----	CR8E
Plug Gap -----	0.8mm
Fuel Type -----	Above 92 (unleaded)
Engine Oil -----	SAE-10W/30
Idling Speed -----	1700±100 rpm

## CAPACITIES

Maximum Load -----	2 riders or 180kg/400lbs
Fuel Tank -----	18L/4Gal
Engine Oil -----	1200cc
Starting -----	5sec.
Climbing -----	20° -25°
Battery -----	12V 12Ah
Head Lights -----	12V 35W/35W
Tail Light -----	12V 21W/5W
Gear Oil -----	SAE140/650cc
Towing -----	500 lbs max

# SPECIFICATIONS

---

## CHASSIS

Front, Rear Brake ----- Hydraulic disc  
Front Tire -----23x7-10 14psi  
Rear Tire -----25x10-12 14psi  
Front Suspension -----Dual A-Arm  
Rear Suspension -----Dual A-Arm  
Restraint System ----- Dual 4-point Harness  
Final Drive Chain ----- 520 x 66

## WEIGHT

Net Weight -----345kgs/761lbs

\*The specifications are subject to change without notice.

# LOCATION OF PARTS

---



# LOCATION OF PARTS



# OPERATION

## A. Operation Controls

**WARNING** - Do not attempt to start or operate the engine until you are completely familiar with the location and use of each control necessary to operate this vehicle. The operator must know how to stop this machine before starting and driving it.

### a. Throttle

The right foot pedal is the throttle that controls the kart speed. As the engine speed increases above idle, the clutch automatically engages and moves the vehicle forward. To disengage the clutch at any time, allow the throttle to return to the idle position.

### WARNING

Each time prior to start the engine, check the throttle assembly to ensure that when the pedal is pushed all the way forward the assembly is working smoothly and returns to idle when released. Do not operate if pedal or engine throttle linkage fail to return to idle. If unable to correct the problem through lubrication, adjustment, or replacement of worn parts, contact your dealer for assistance.

### b. Brake

The brake is located on the left side of the kart. Applying pressure to the pedal draws the brake caliper around the brake pump at the rear wheel and slows or stops the kart.

### c. Start engine.

Insert the key into key-switch, turn the key clockwise, release the key when the engine starts. Kart must be in neutral. The engine will warm up within 5 minutes if the engine is cold you will need to pull the choke lever under the seat. (Warning: Don't crank starter more than 5 seconds at one time).

### e. Engine stop button.

#### IMPORTANT STOP BUTTON TEST

Before driving this vehicle, test the engine stop button to assure that it is operating properly. With the engine running, push and hold the engine stop button for two seconds for the engine to shut down.

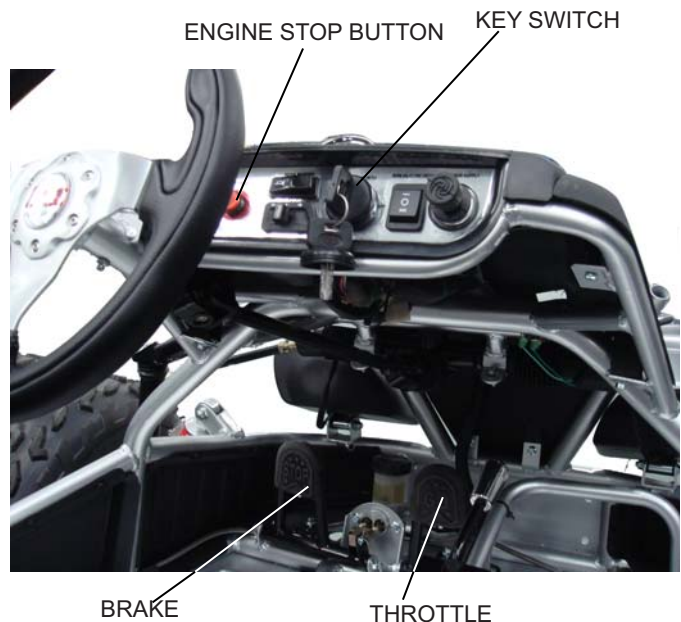



# OPERATION

## B. Pre-Drive Inspection



### WARNING

**Perform this pre-drive inspection everyday before driving vehicle. If not performed, serious damage to the vehicle or personal injury may result.**

- a. Check engine oil level. Check for leaks, add oil if required.
- b. Check fuel level. Add fuel as necessary and do not overfill. Check for leaks.
- c. Check brakes. Depress the rear brake pedal several times, then check for proper brake pedal freeplay. Make sure there is no brake fluid leakage. Adjust if necessary.
- d. Check tires. Check tire condition and pressure. The pressure on both front and rear tires is 14 psi, respectively.
- e. Check drive chain. Check drive chain's condition and tension. Lubricate if necessary.
- f. Check throttle. Check for smooth operation. Assure throttle "snaps" back to idle.
- g. Check engine stop button. Perform engine stop button test. Repair as necessary.
- h. Check all nuts, bolts, and fasteners. Check wheels to see that all axle nuts and lug nuts are tightened properly. Check and tighten as necessary all other fasteners to specified condition.
- i. Check occupant protection bar. Ensure all occupant protection bars are in place before operating the kart.
- j. Check brake light. Check for proper operation.
- k. Check wheels. Check for tightness of wheel nuts and axle nuts; check that axle nuts are secured by cotter pins.
- l. Check steering. Check for free operation for any unusual looseness in any area.



### WARNING

**Always follow rules for safe operation and wear a helmet.**

# OPERATION

## C. Passengers

The vehicle allows for two riders only. Combined maximum weight of driver and the passenger should not exceed 180kg or 400lbs.

## D. Seat Adjustment

The seat must always be securely fastened in the position which best affords the operator control of the foot pedals, steering wheel, and the remote stop button.

- Pull seat adjustment handle upward to disengage seat slide.
- Move seat to desired position.
- Be sure seat adjustment handle snaps back into place and that seat is locked into position.



SEAT ADJUSTMENT HANDLE

### WARNING

Before attempting to adjust the seat, ensure that kart engine is stopped.

### WARNING

Never operate this buggy when the provided seat is not securely fastened, to do so could result in a strong possibility of severe personal injury or loss of life. Before attempting to adjust the seat, ensure the kart engine is stopped.

## E. Parking Brake Adjustment

- Push forward the brake lever so that the unit can roll freely. Pull back the lever to engage the parking brake.  
  
b. When brake lever is in forward position, there needs to be 1/2" of freeplay. If the adjustment is not correct, loosen lock nut #2, then adjust lock nut #1 to the proper amount of freeplay.

Always stop the kart before changing gears.



ADJUSTING NUT #1,  
REVERSE CABLE

# OPERATION

## F. Gear Shift Lever

### YOKE ADJUSTMENT

- Each end of the cable has a threaded yoke on it.
- You must remove the pin or bolt in either end of the cable to which the yoke is attached.
- To adjust an end, loosen the jam nut and turn the yoke the appropriate way.

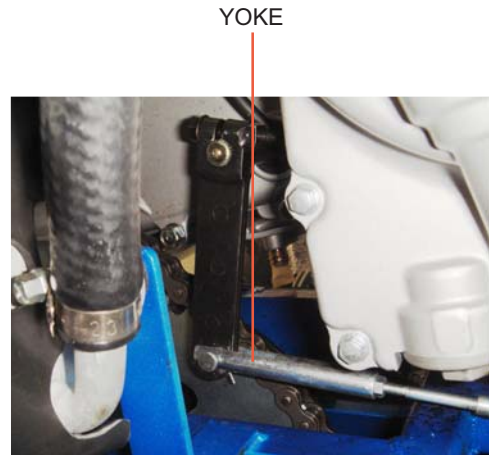

### CABLE MOUNT ADJUSTMENT

- The cable has a threaded stud and jam nuts on each end that is used to attach itself to the frame.
- To adjust, loosen one jam nut on one or both ends and adjust the appropriate direction.
- Tighten jam nuts.

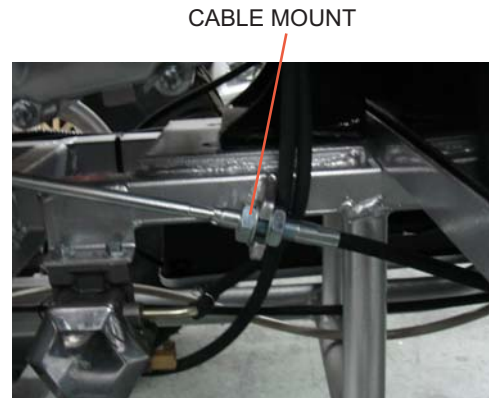

### SHIFT LEVER ADJUSTMENT

- On the rear end of the cable a shift lever is attached to both it and the engine.
- The lever is on a splined shaft protruding from the engine.
- Remove the bolt which holds this lever to the engine.
- Slide the lever off the shaft and turn the appropriate way, one spline at a time.
- Once in the appropriate position tighten all bolts back.



# OPERATION

---

## **G. Starting And Operating Instructions**

- a. Before starting the engine, be sure that the driver is seated properly in the kart with the seat belt fastened.
- b. Test the kart in an open space at the beginning to learn how to start, turn, and stop.
- c. Operate the kart slowly until you are familiar with it.
- d. The turning radius of this kart is small and agile, so the centrifugal force is very high when turning at high speed. Slow down to a more controllable speed when turning to prevent the kart from rolling over.
- e. Always turn the vehicle at a slow, controllable speed to prevent the vehicle from turning over. Keep your left foot ready to press the brake. If at any time the vehicle feels unstable, reduce your speed.

# PERIODIC CHECK AND SERVICES

Have your kart checked, adjusted, and record maintenance performed. Have these services performed periodically by your Carter Authorized Dealer to maintain the kart at the optimum condition.

Item	Every 300km 180 mi	1 Month	3 Months	6 Months	1 Year
Air Cleaner	I	C			R
Fuel Filter	I			I	R
Engine Oil Change	R	Replacement for every 1000 km/600 miles			
Tire Pressure	I	I			
Battery Inspection	I	I			
Brake Check	I	I			
Steering Check	I			I	
Tightness of Screws	I	I			
Frame Lubrication				L	
Gear Oil Check	I	I			
Gear Oil Change	R	Replacement for every 5000 km/3000 miles			
Spark Plug	I		I	R	
Exhaust Pipe	I	I			
Ignition Timing	I	I			
Emission	I	I			
Throttle	I	I			
Engine Bolt Tightening	I		I		
CVT Driving Device (belt)				I	R
CVT Driving Device (roller)				C	
Drive Chain	I/L	I/L		C	
Lights/Electrical Equipment	I	I			
Fuel Lines	I		I		
Cam Chain	I		I		
Valve Clearance	I		I		
Lines/Cooling Connections	I	I			
Coolant Reservoir	I	I			
Coolant	I	I			R

Code:            I=Inspection, Cleaning and Adjustment            R= Replacement  
                       C=Cleaning (replace if necessary)                L=Lubrication

The above maintenance schedule is established by taking the monthly 1000km/600 miles as a reference, which ever comes first.

Clean or replace the air cleaner element more often when the kart is operated in a dusty or polluted environment.

Maintenance should be performed more often if the kart is frequently operated at high speeds and after the kart has accumulated higher mileage.

# SERVICE INSTRUCTIONS

## Torque Values

The torque values listed in this table are for more important tightened torque values. Please see standard values for torques not listed in the table.

## Torque Tightening Chart

Bolt Diameter	Conventional Marked Bolt			8.8 Marked Bolt		
	N.m	Kg.m	lb-ft	N.m	Kg.m	lb-ft
4	1 ~2	0.1 ~0.2	0.7 ~1.5	1.5 ~3	0.15 ~0.3	1.0 ~2.0
5	1 ~4	0.2 ~0.4	1.5 ~3.0	3 ~6	0.3 ~0.6	2.0 ~4.5
6	4 ~7	0.4 ~0.7	3.0 ~5.0	8 ~12	0.8~1.2	6.0 ~8.5
8	10 ~16	1.0 ~1.6	7.0 ~11.5	18 ~28	1.8 ~2.8	13.0 ~20.0
10	22 ~35	2.2 ~3.5	16.0~25.5	40 ~60	4.0 ~6.0	29.0 ~43.5
12	35 ~50	3.5 ~5.5	25.5 ~40	70 ~100	7.0 ~10.0	50.5 ~72.5
14	50 ~80	5.0 ~8.0	36.5 ~58	110 ~160	11.0 ~16.0	79.5 ~115.5
16	80 ~130	8.0 ~13.0	58 ~94	170 ~250	17.0 ~25.	123.0 ~181.0
18	130 ~190	13.0~19.0	94 ~137.5	200 ~280	20 ~28.0	144.5 ~202.5

## A. Service Air Cleaner

Service air cleaner every 20 hours after riding  
NOTE: Service more often under dusty conditions.

- Loosen 4 hooks from the air cleaner cover and then remove the cover.
- Loosen the clamp strip and 1 screw of air cleaner element, and then remove the air cleaner element.
- Clean the element with non-flammable or high-flash point solvent and then squeeze it dry.

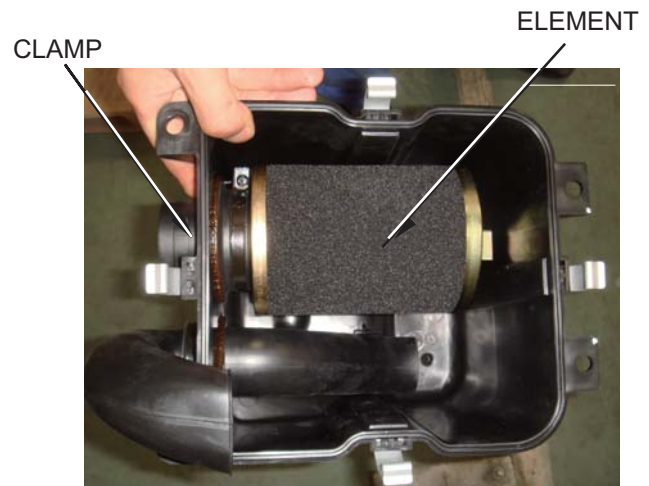

### WARNING

Never use gasoline or acid organized solvent to clean the element.

Soap the element in clean engine oil and then squeeze it out. Install the element on the element seat and then install the air cleaner cover.

# SERVICE INSTRUCTIONS

## B. Engine Lubrication

You must change the oil in the crankcase after the first 5 hours of operating your new engine and after 10 hours of use thereafter. This will insure proper lubrication of internal parts and prevent costly repairs due to excessive wear.

### WARNING



Used oil must be disposed of at a proper collection center.

- Remove drain plug located on the right rear side of engine. Tip buggy backwards slightly by blocking the front tires and drain oil into suitable container.
- Remove and clean oil screen.
- Replace drain plug and tighten securely. Place kart in a level position.
- Refill crankcase (approximately 1200 cc or 1 1/4 quarts) to top of filler neck with SAE 10W 30 oil.
- Check oil level before each use of kart or after each 10 hours of operation. Add oil to bring up to proper level. Do not mix various grades of oil.



ENGINE OIL PLUG COVER

## C. Gear Oil Check and Change

- Remove oil join bolt. Remove drain bolt and drain oil out.
- Install the drain bolt after drained. **Torque value: 1.1~1.5kgf-m**
- Make sure that the drain bolt washer can be re-used.
- Add oil to specified quantity from the join hole.  
**Gear Oil Quantity: 650 cc when replacing.**
- Make sure that the join bolt washer can be re-used, and install the bolt. **Torque value: 3.5~4.5kgf-m**
- Start engine and run engine for 2-3 minutes. Turn off engine and make sure that oil level is at correct level. Make sure that there is no oil leakage.



DRAIN BOLT

# SERVICE INSTRUCTIONS

## D. Carburetor Adjustment

Never make unnecessary adjustments. The factory recommended settings are correct for most applications.

### WARNING

Air screw was set at factory, so no adjustment is needed. Note the number of turns it takes to screw it all the way in for ease of installation. The parking brake must be used to stop the kart to perform the adjustments.

- Warm up engine (5~10min).
- Tighten the air screw gently. Backout 2 turns.
- Connect the tachometer, adjust the throttle to limit the idle speed. The standard value is 1700 RPM.
- Turn the air screw counter-clockwise slowly and observe the RPM of the engine, stop adjusting as the RPM reaches top speed.
- Adjust the screw and adjust the idle speed to an ideal value.
- Recheck and readjust the idle speed if necessary.

THROTTLE VALVE STOPPER SCEW

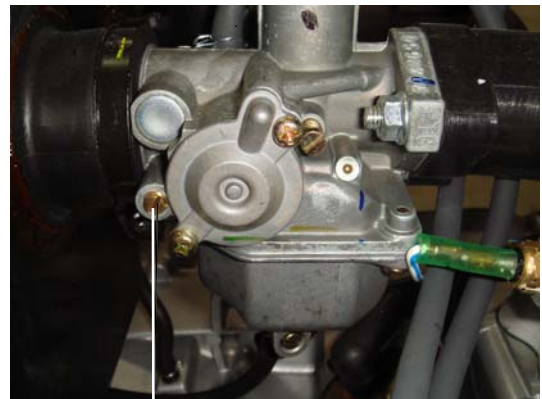

AIR ADJUSTMENT SCREW

## E. Spark Plug

- Remove the spark plug and inspect it each time you change the oil. (Use a spark plug wrench). Keep the electrodes clean and free of carbon. The presence of carbon or excess oil will gently reduce proper engine performance. If possible, check the spark plug gap (area between electrodes) using a wire feeler gauge. This specification is 0.8~0.9mm.
- Before installing the spark plug, coat threads lightly with graphite grease, if possible, to ensure easy removal in the future.
- It is advisable to replace the spark plug at least once a year to insure easy starting and good engine performance.

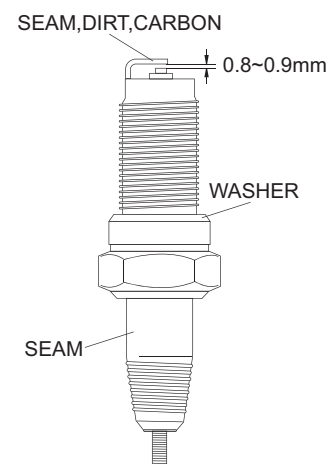



# SERVICE INSTRUCTIONS

## F. Cleaning Instructions

Keep your kart clean. With clean rag, wipe off dirt and oil from around controls. Wipe off any spilled fuel and oil. Keep the engine clean of foreign objects, and be sure to check that air intake fan is free of debris for proper cooling.

## G. Drive Chain

### How to Tighten Chain:

- On this unit in order to tighten the chain the entire engine must be "slid" forward.
- Loosen the engine plate bolts (2 front and 2 rear).
- Loosen air box bolts (4 total).
- Loosen muffler bolts (2 total).
- Slide engine forward and tighten all bolts.

### How to Lubricate Chain:

Lubricate chain with a spray-on type chain lubricant to increase the life of the chain.

NOTE: When pushing the engine forward the front engine mount will try and tilt forward. This will cause the engine to return to its original position once force is removed. You will need to tap the bottom of the engine plate to keep it from tilting. Check gear positions after adjusting chain.

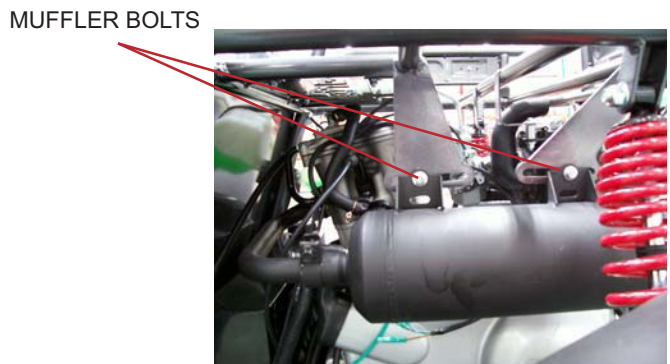
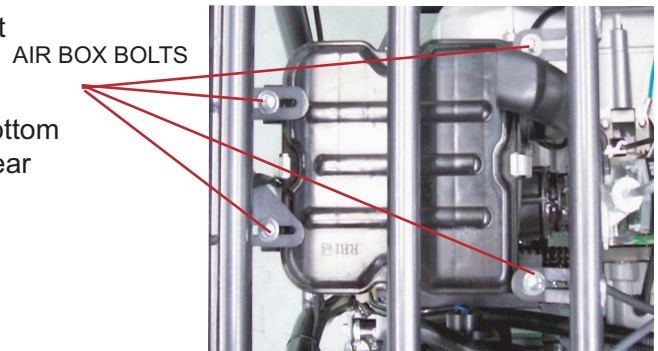
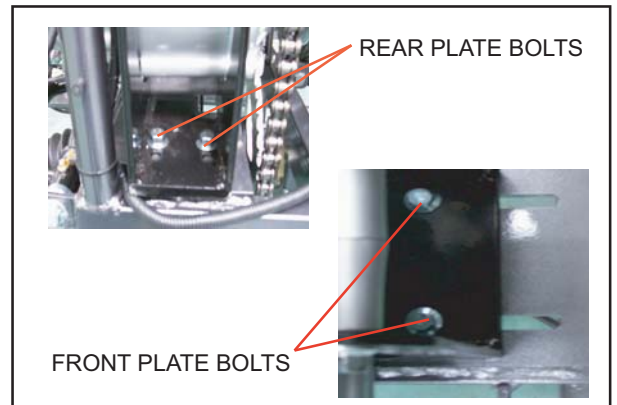
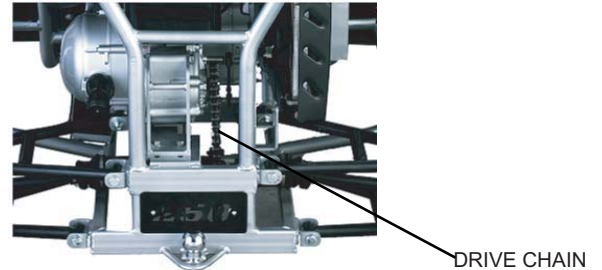

# SERVICE INSTRUCTIONS

## H. Adjustment of Front and Rear Shocks

There are five adjustable positions on each shock. The default position is in the middle.

- Use a round nut wrench to adjust the shock.
- The tension of the shock spring will increase as you screw to the right.
- Adjust accordingly to the weight of the riders.

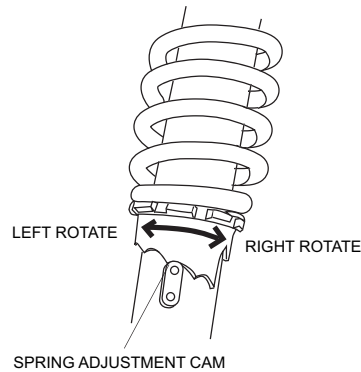

## I. Front or Rear Shock Removal

- You must first lift either the front or the rear of the kart off the ground, depending on which shocks you want to remove.
- Once the kart is off the ground remove the bolt from both top and bottom of each shock.

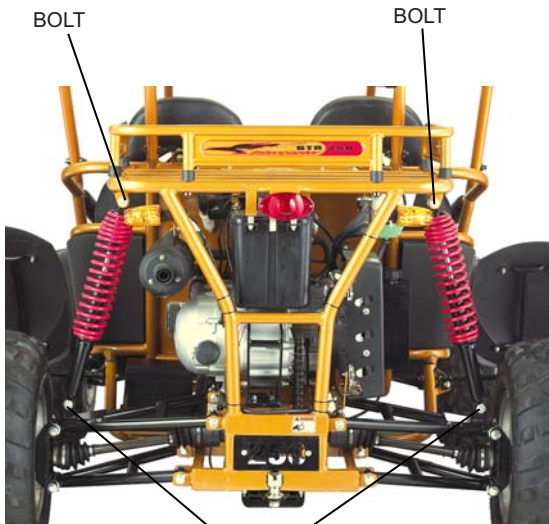

**REAR SHOCKS**



**FRONT SHOCKS**

# SERVICE INFORMATION

---

## J. Front Wheel Replacement

Do not disassemble the castle nuts when you replace the front wheels. It is only necessary to remove the four 4 lug nuts to remove the wheel. Tighten the nuts after replacing the wheels.



## K. Rear Wheel Replacement

Do not disassemble the castle nuts when you replace the rear wheel and hub assembly. Remove the cotter pin and the 24mm nut. Then slide off wheel and hub assembly. It is only necessary to remove the four 4 lug nuts to remove the wheel by itself.



# SERVICE INFORMATION

## L. Front Wheel Alignment

a. The front wheels should be “toe-in” from 1/8” to 1/4”. To check for alignment, measure distance A and B between the centerline (CL) of the wheels. The proper toe-in dimension A should be 1/8” – 1/4” greater than dimension B.

b. To adjust the alignments, loosen the lock nuts on both sides of Front Tie Rods. To make Dimension B smaller, turn the rod to the left. Adjust the rod to the right direction to make Dimension B larger. After adjusting to the desired length, tighten the lock nut against the rod end. Recheck the dimensions for proper alignment.

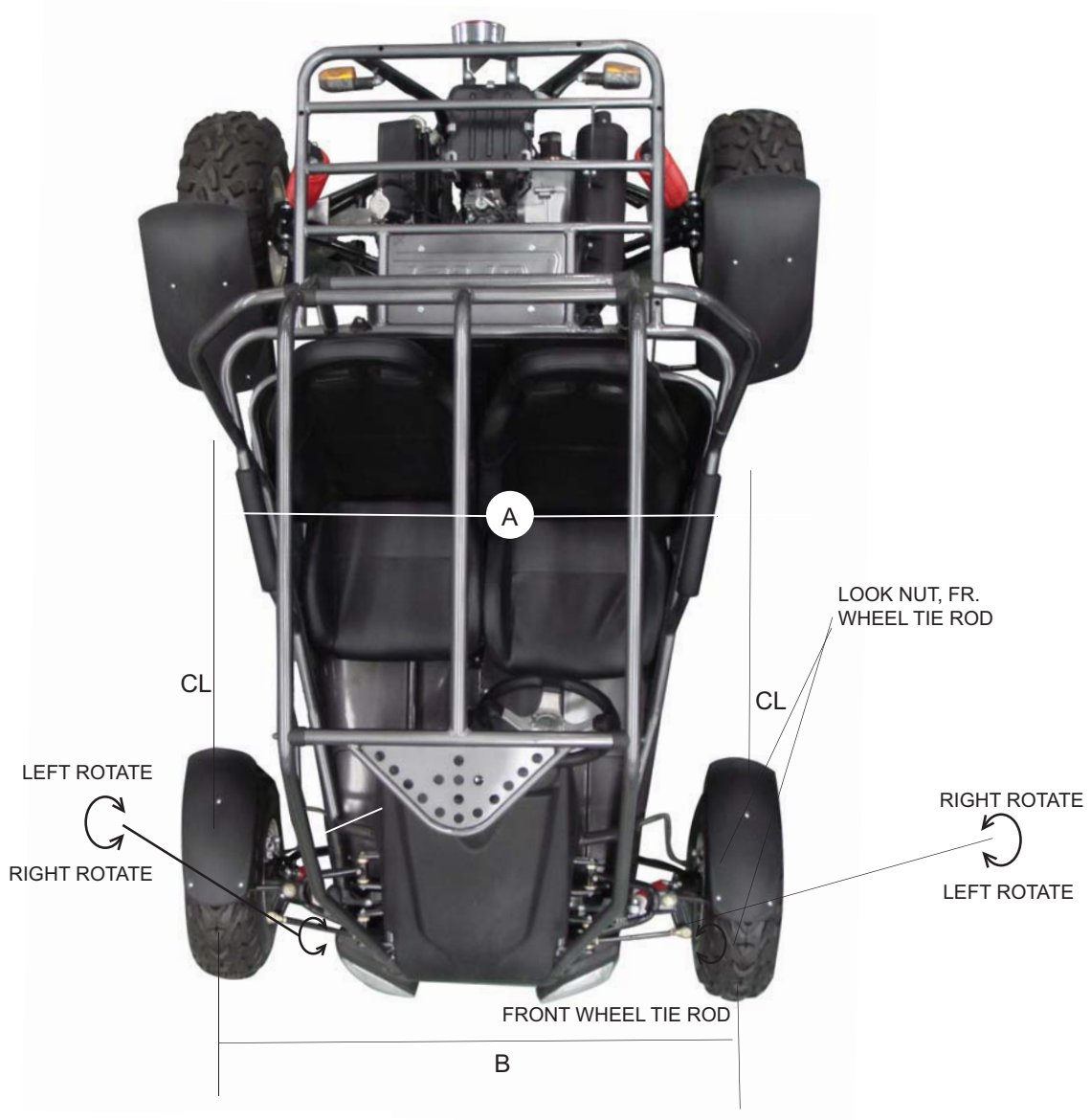

# SERVICE INFORMATION

## M. Fuel Switch (Petcock)

This vehicle has a manually operated fuel petcock with three positions. Please follow maintenance procedures accordingly.

- a. Periodically clean the petcock externally with grease remover and water.
- b. Check for any leaks or seeping fuel.

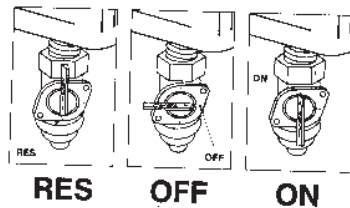

### “ON” Position

The normal operating position for the fuel valve lever is the “ON” position. In this position, fuel will flow to the carburetor.

### “RES” Position (Reserve)

If the fuel level in the fuel tank becomes too low for the engine to operate with the fuel valve lever in the “ON” position, turn the lever to the “RES” position to use the reserve fuel supply, and refuel as soon as possible.

### “OFF” Position

The closing position for the fuel valve is the “OFF” position. When the vehicle is not in use, always make sure the petcock is in the “OFF” position.

## N. Chassis

Grease chassis bushings and bearings with grease every six-months to assure smooth operation and extended life of the bushings and the components. If used in extreme wet, muddy, or dusty conditions, greasing is recommended more often.

# SERVICE INFORMATION

## O. Steering Shaft

a. Remove the nuts from steering block. Grease inside of steer-block periodically.

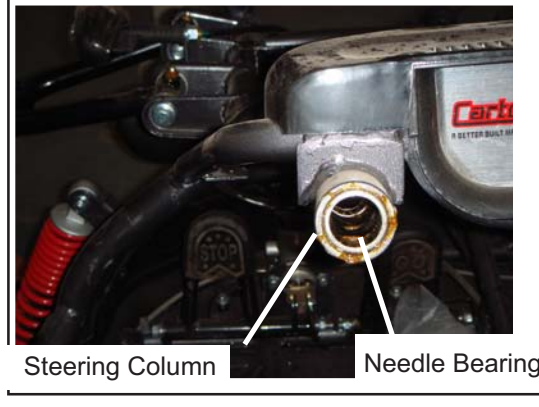
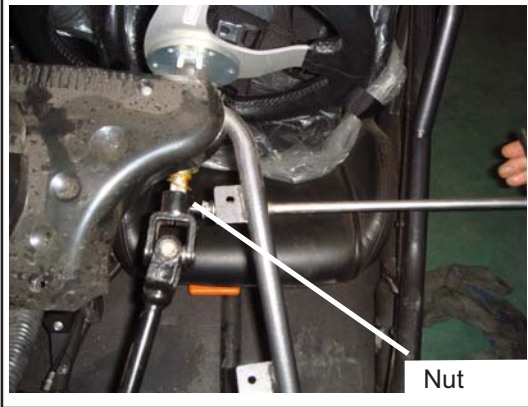

b. Loosen steering shaft, clamp nut and steering gear box.

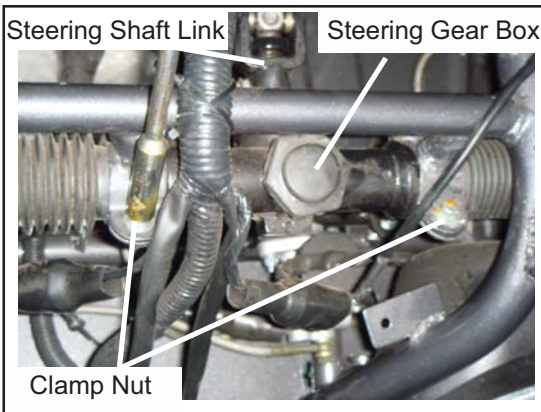

c. Remove steering shaft.

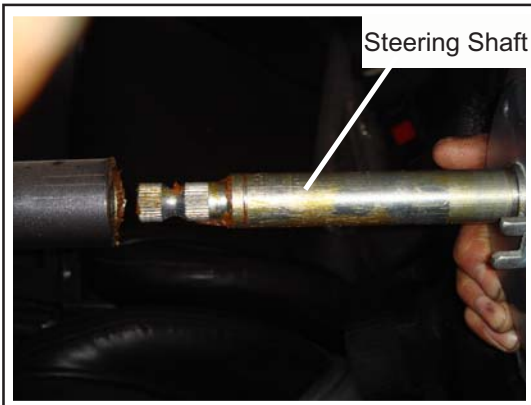

# SERVICE INFORMATION

## P. Steering Gear Box and Ball

### HEAD AND STEERING GEAR BOX

a. Remove four bolts on LH and RH clamp nut and steering gear box.

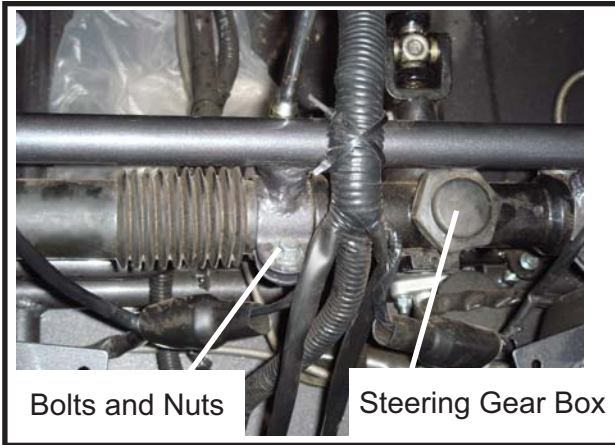

b. Remove and check ball head dust cover and steering gear box for wear.

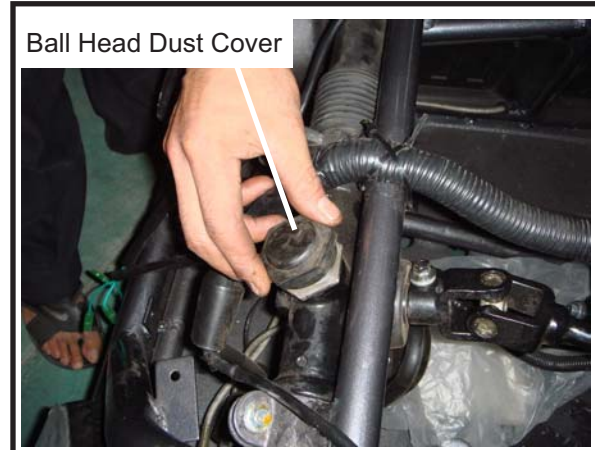

c. Check steering cover on sides of steering gear box and grease the ball head.



d. Fill steering gear box with grease after cleaning the dust. Replace the ball joint if it is loose or not smooth.

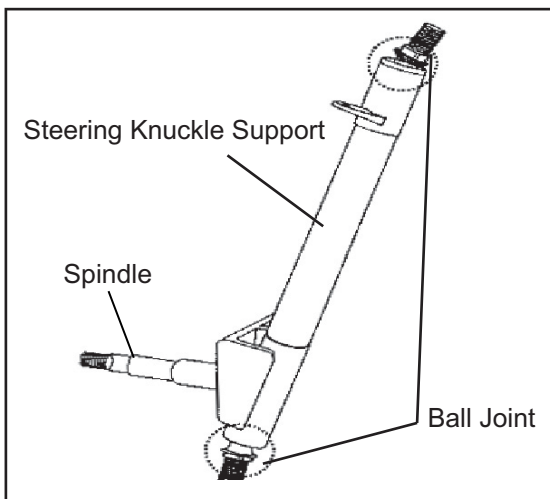

# SERVICE INFORMATION

## Q. Steering Knuckle Support

- a. Remove rubber dust cover of the knuckle support.

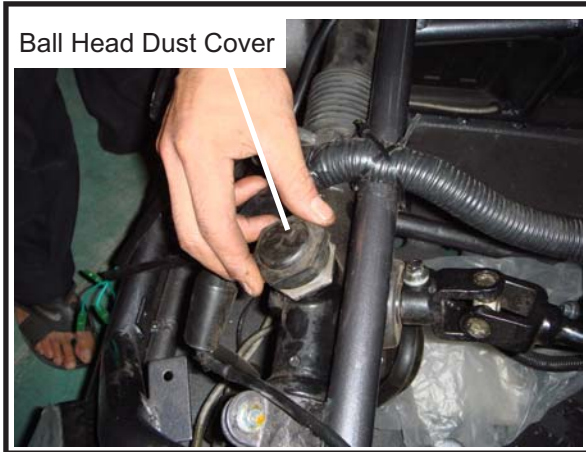

- b. Check the grease of ball joint. Clean it if it is dirty and fill with grease.



- c. Replace the steering knuckle support if the ball joint is loose or steering isn't flexible.

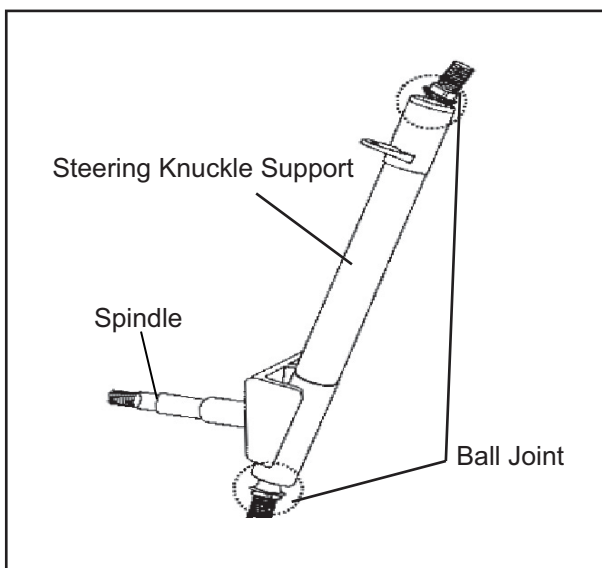



# SERVICE INFORMATION

## R. Throttle and Brake Pedal

- Remove throttle, throttle pedal and axle nut, check for signs of wear. Replace if wear is present.
- Fill with grease in order to make the throttle and brake pedal swing more flexibly before installation.



## S. A-Arms

- Grease the flex points of the upper and lower A-arm, front wheel periodically.
- Remove bolt of upper and lower A-arm, front wheel.
- Check the nylon bushing of upper and lower A-arm, front wheel for wear. Replace immediately if wear is present.

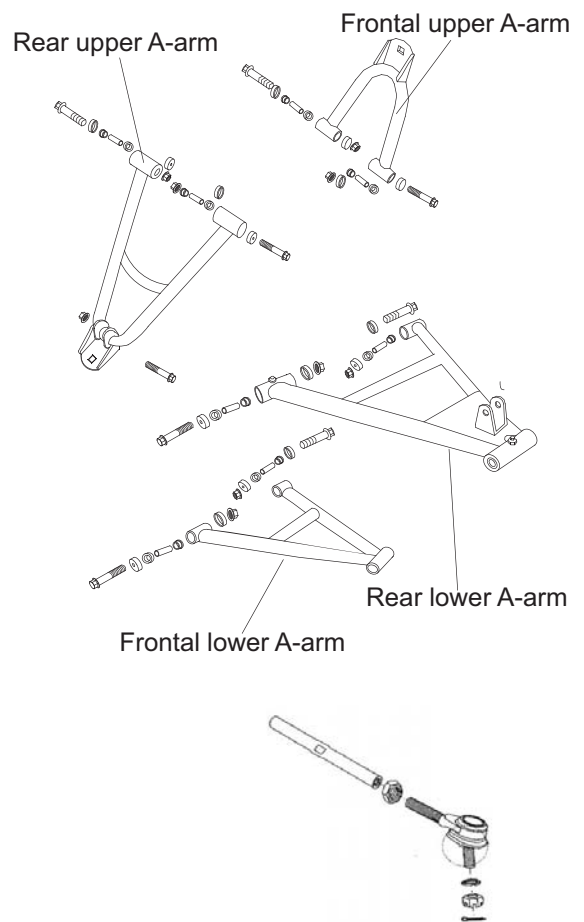

## T. Tie Rod

- Tie rods should be checked for ease of movement in their full rotation.
- Remove protective boot and apply grease.
- Check tie rod ends periodically for tightness at the adjusting nuts.
- Always use a new cotterpin after removal.

## U. Seat

- Remove all the nuts and bolts underneath the seat rail.
- Remove seat.



# SERVICE INFORMATION

## V. Radiator

### WARNING

**While engine is running, never attempt to open the radiator filler cap. The pressurized hot coolant may shoot out and cause serious scalding injury. No maintenance work is allowed to be performed unless the engine is completely cooled down.**

- a. Refill the radiator with distilled water or specified additives.
- b. Add coolant to the reservoir.
- c. The cooling system can be serviced on the buggy.
- d. Never spill the coolant on the painted surface.
- e. Test the cooling system for any leakage after the repair.



## W. Storage Instructions

### WARNING

**Do not drain fuel while engine is hot. Be sure to move kart outside before draining fuel.**

In the event that your buggy is not to be operated for a period exceeding 30 days or at the end of each driving season, prepare for storage as follows:

- a. Drain fuel tank and carburetor by allowing engine to run out of fuel and use a fuel stabilizer.
- b. Lubricate engine cylinder by removing the air cleaner, then spray engine, fogging oil through the carburetor until motor dies.
- c. Do not save or store gasoline over winter. Using old gasoline, which deteriorates from storage, will cause hard starting and affect engine performance.

# SERVICE INFORMATION

## X. Front Hubs

- a. Check seals for rips or tears and replace if any exist.
- b. Inspect bearings for ease of movement. If bearings are dirty or muddy, wash them in cleaning solvent and spin with your finger. Never spin them with compressed.
- c. Apply an ample amount of grease to the bearing and reinstall with bearing tool, making sure it goes in straight: Damage to the hub can occur.
- d. Install seals into hub. It is recommended to apply a small amount of grease to the lip of the seal. If the retention spring is in bad shape, replace the seal with a new one.



# WIRING DIAGRAM

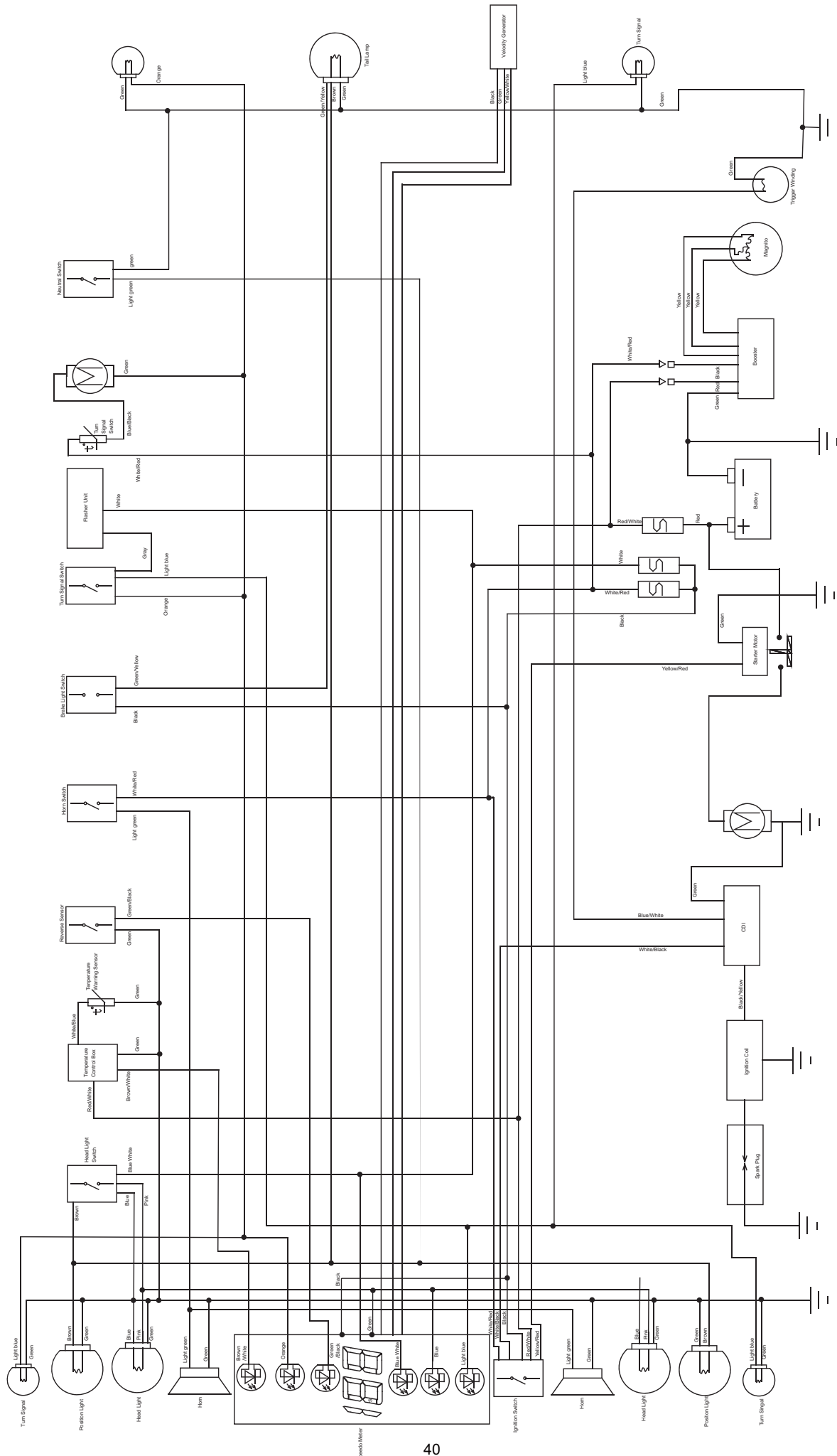

# TROUBLE SHOOTING CHARTS

## A. Engine hard to start or can not be started.

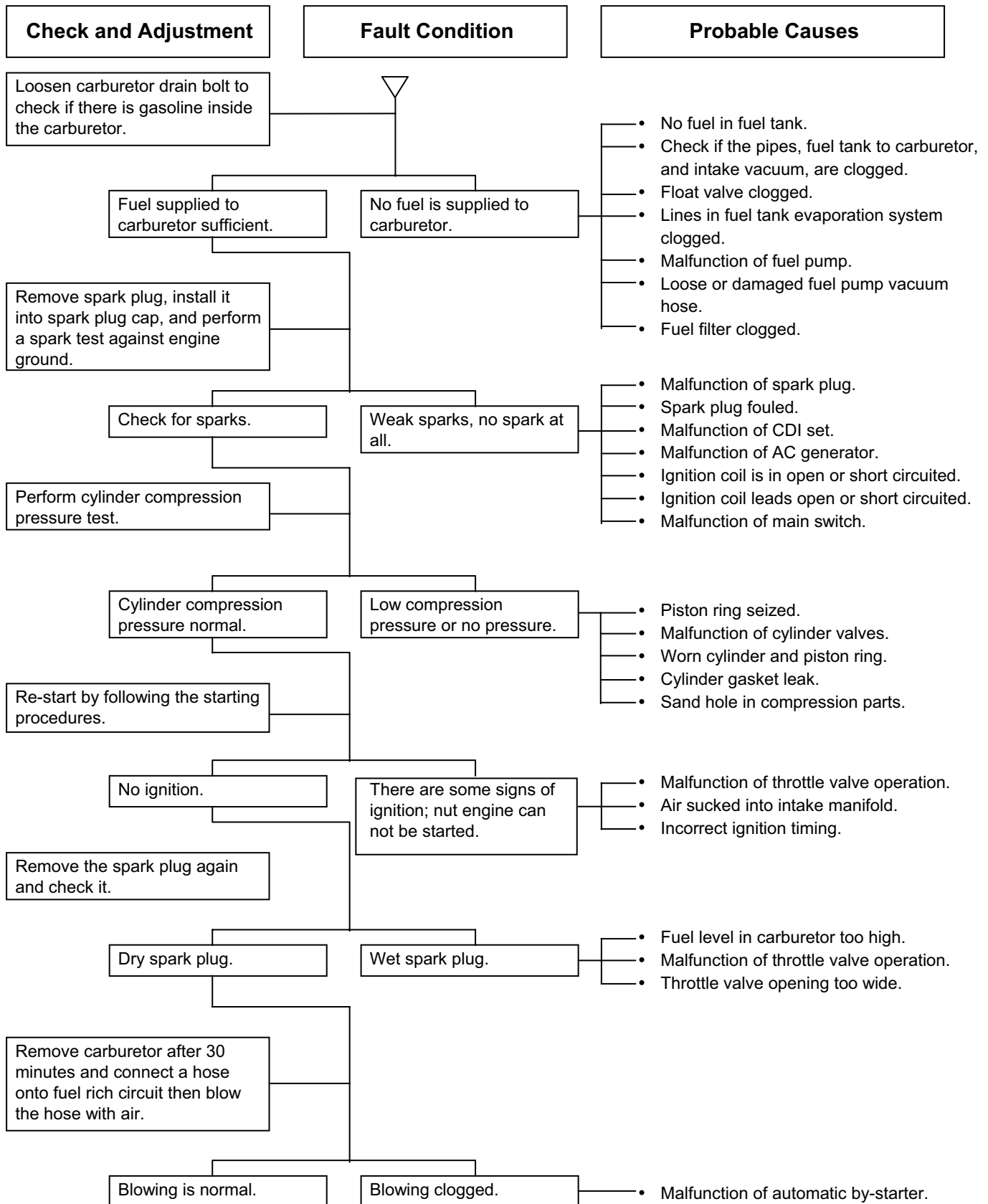

# TROUBLE SHOOTING CHARTS

## B. Engine Runs Sluggish (Speed does not pick up, lack of power).

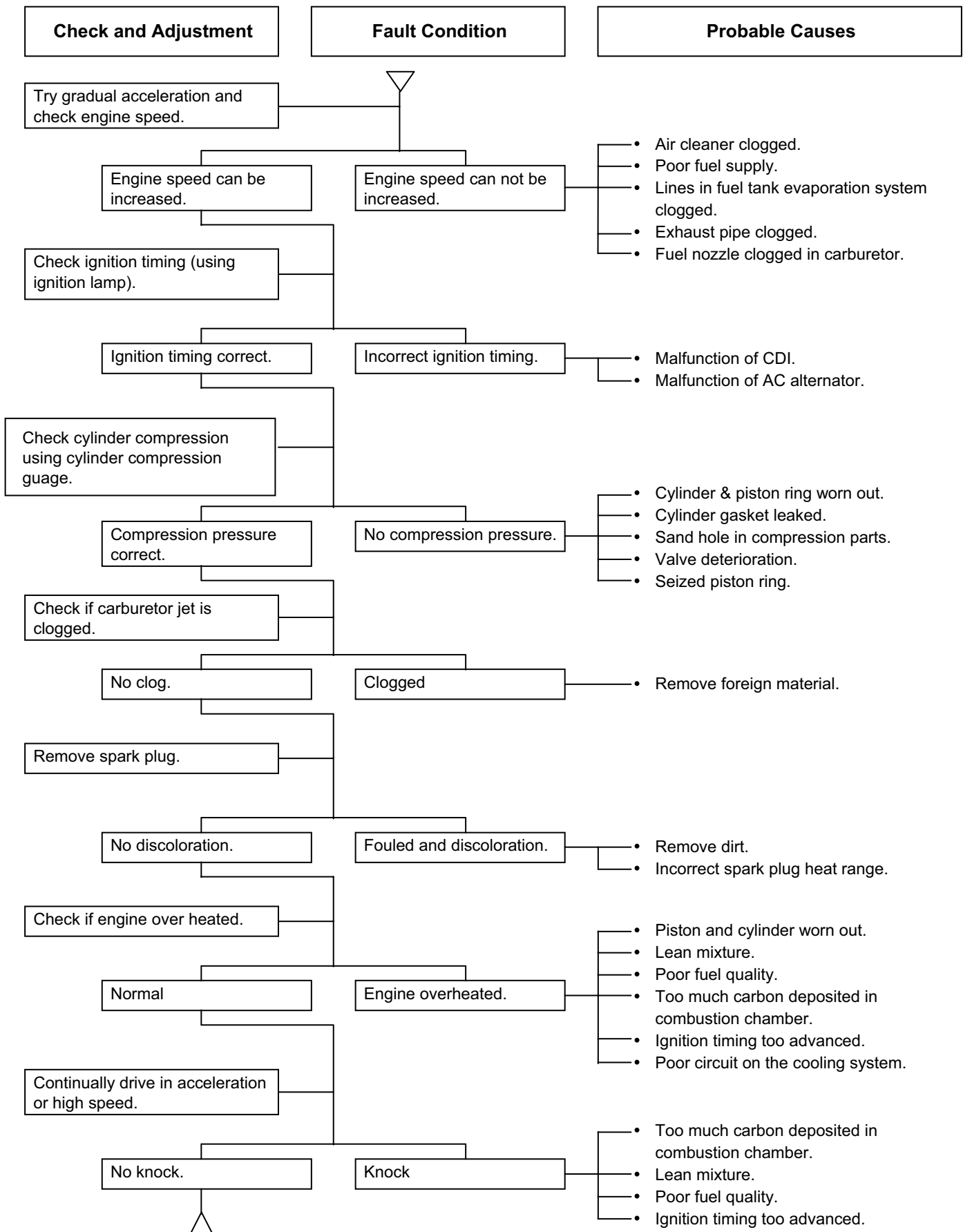

# TROUBLE SHOOTING CHARTS

## C. Engine Runs Sluggish (especially in low speed and idling)

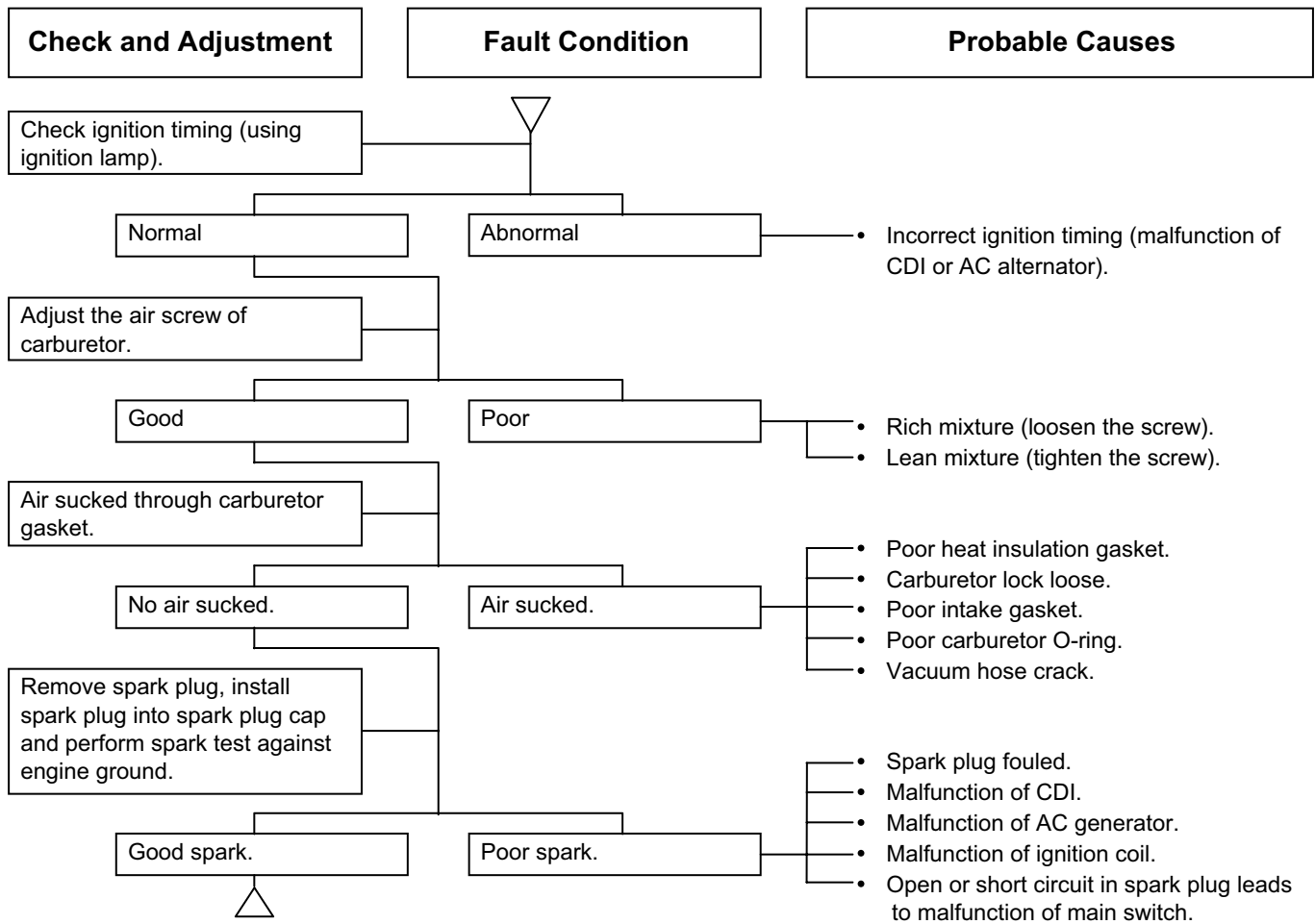

## D. Engine Runs Sluggish (High speed)

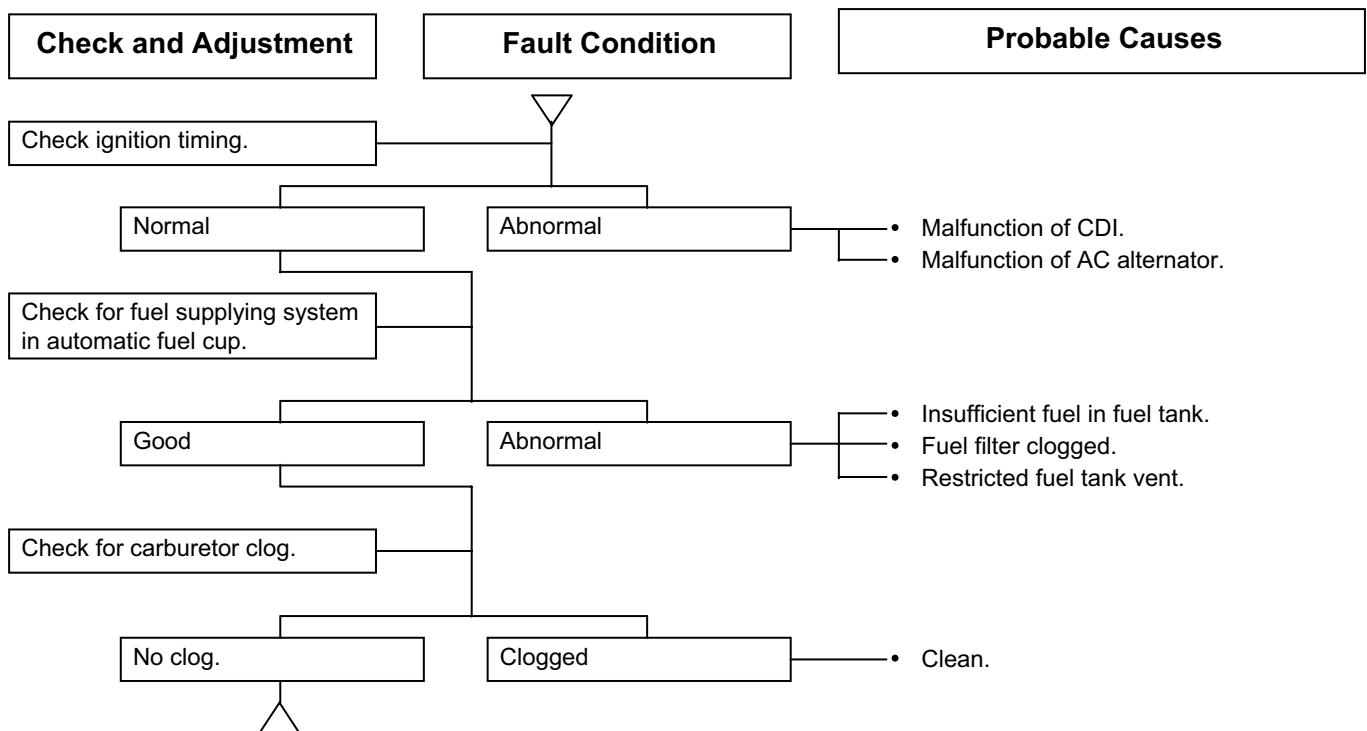

# TROUBLE SHOOTING CHARTS

## E. Clutch, Driving and Driving Pulley

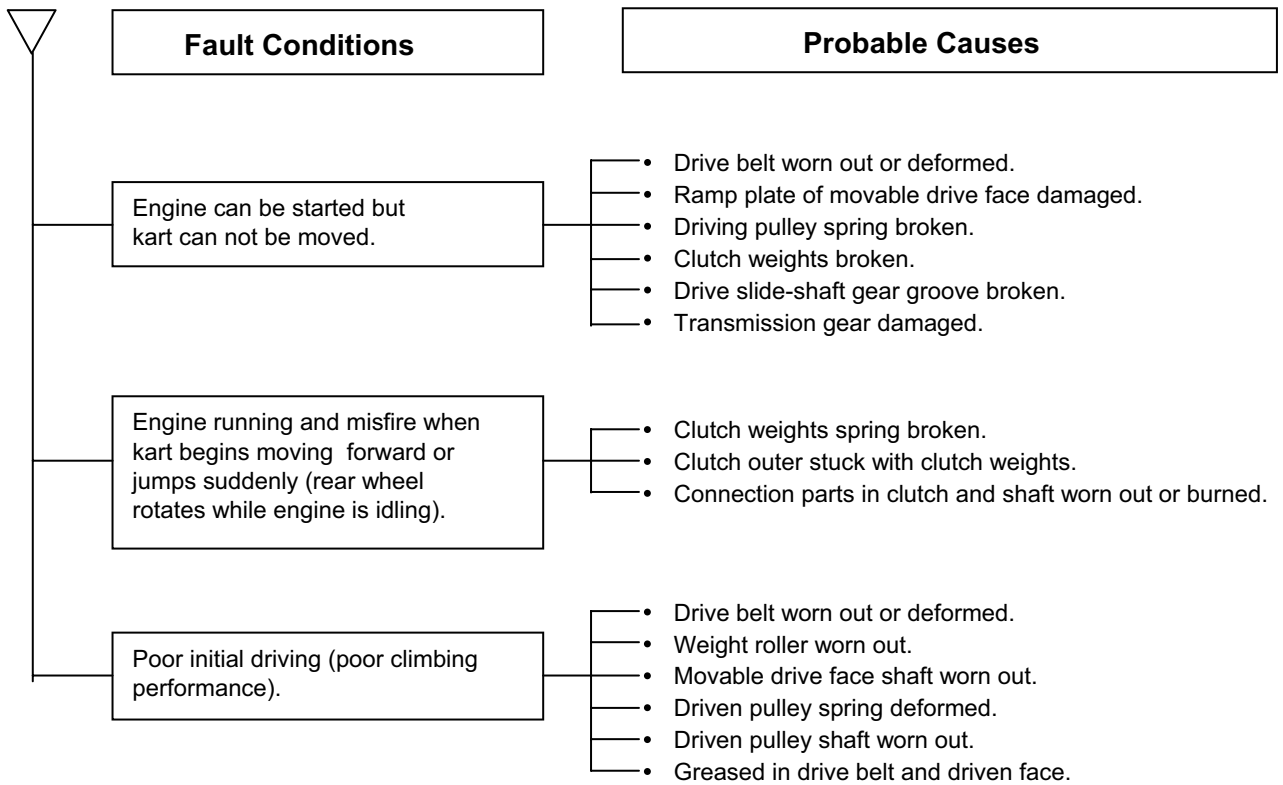

## F. Poor Handling

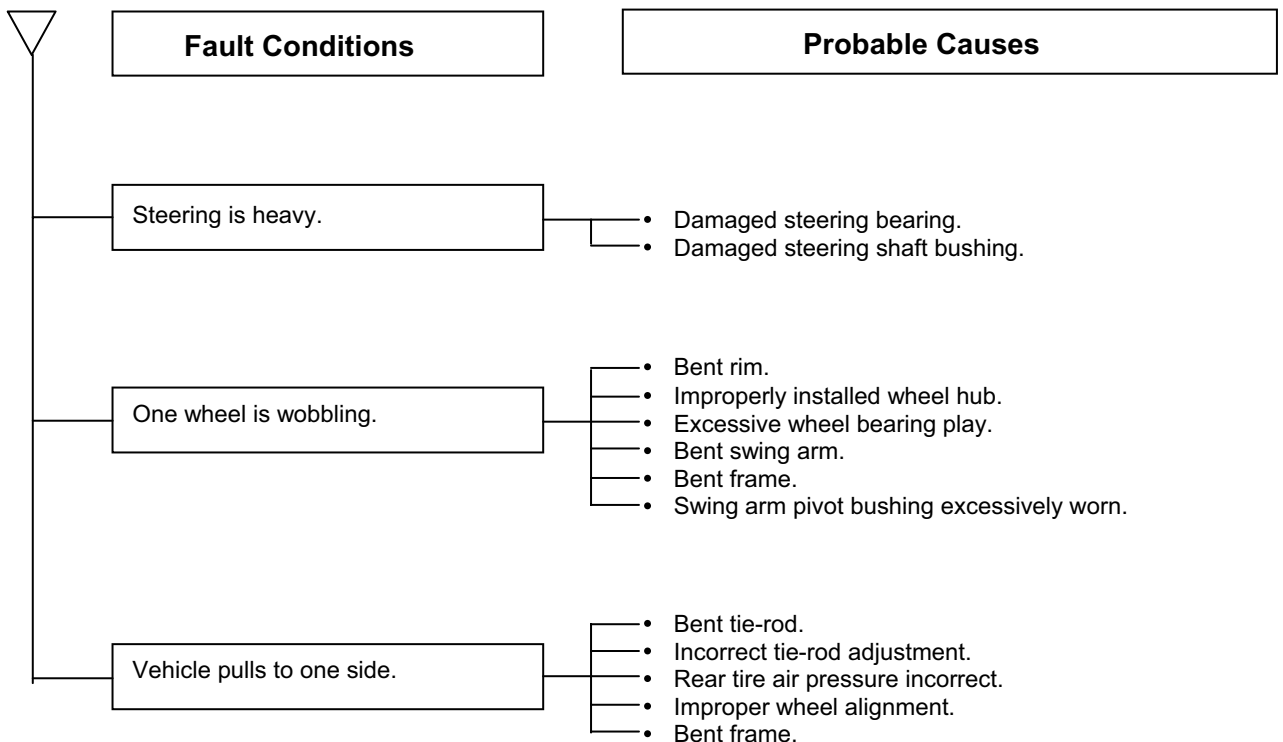



# TROUBLE SHOOTING CHARTS

## G. Lose Power

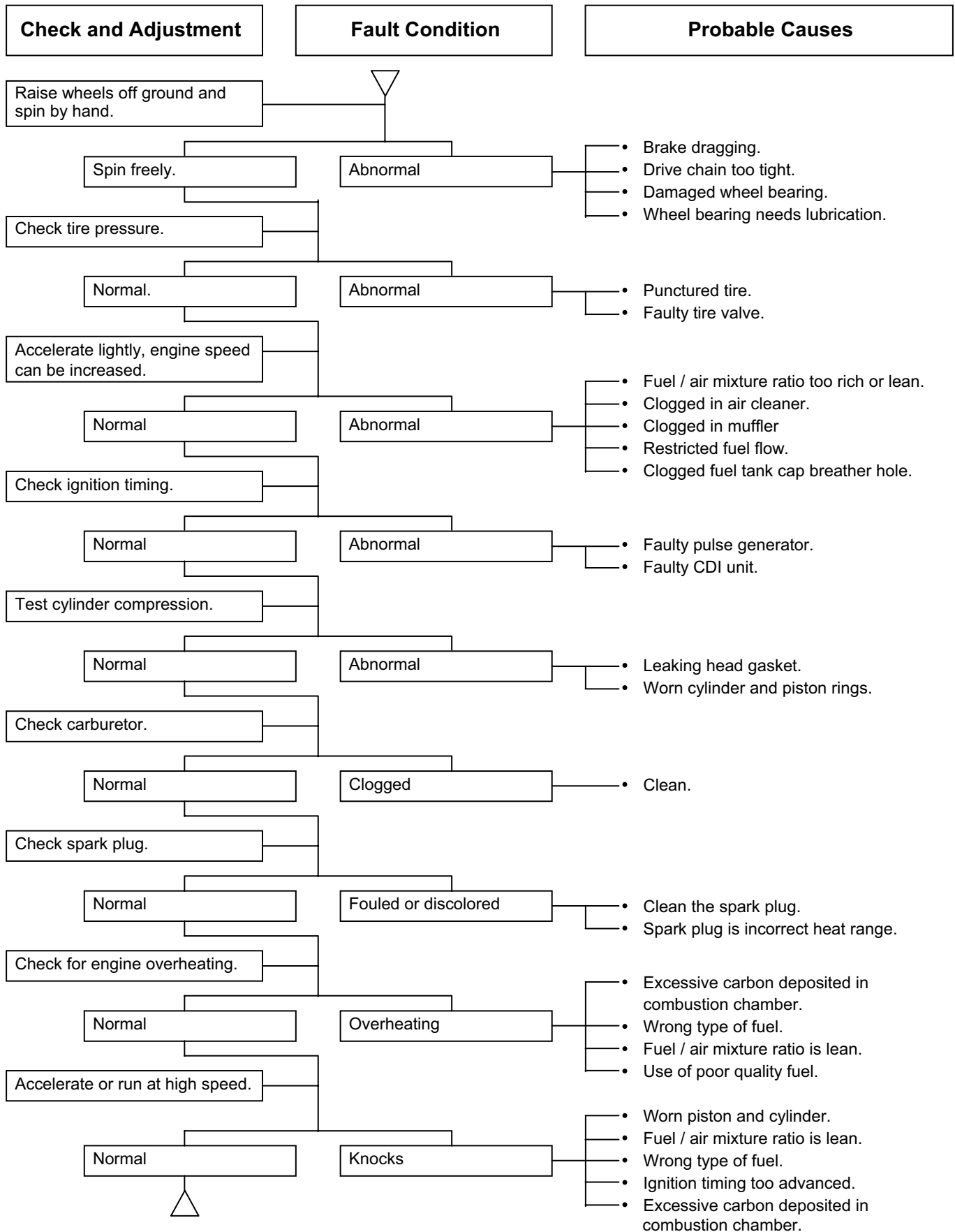

# SET-UP INSTRUCTIONS

## INTERCEPTOR GTR 250

### TOOLS NEEDED

Floor jack  
Needle nose pliers  
Protective gloves  
Metric wrench and socket set  
Flat head screw driver  
Phillips head screw driver  
Adjustable wrench

#### 1. LIFT THE KART

In order to assemble the front suspension and steering the unit must be lifted high enough to put the front tires on it. Place a floor jack under the front of the unit in the center and lift the kart

#### 2. FRONT TOP A-ARM

- Insert top a-arms into top front suspension mounts with the grease fittings pointing upwards. The top a-arms are the shortest a-arms. The mounting brackets are located both in front and behind of each front blinker.
- Tighten bolts with 13mm and 14mm wrench.



#### 3. FRONT BOTTOM A-ARM

- Insert bottom a-arms into bottom front suspension mounts with the grease fittings pointing downwards. The bottom a-arms have shock mount brackets. The mounting brackets are located underneath the floorboard.
- Tighten bolts with 13mm and 14mm wrench.



#### 4. FRONT SHOCK

- Place the bottom eye hole of the shock into the shock mounts on the bottom a-arms & insert bolt.
- Place the top eye hole of the shock into the shock mount located on the frame and insert bolt.
- Tighten bolts with 13mm and 14mm wrench.



#### 5. FRONT STRUT

- On each end of the struts is a threaded stud. On the bottom of each stud you can see a square.
- Align each square of the threaded stud with that of the tabs on each a-arm. The squares of the stud and a-arms **MUST** be aligned.
- Be sure the steering arm on each strut is pointing towards the front of the unit.
- Tighten each castle nut with an 18mm wrench and **lock into place with a cotter pin and needle nose pliers**. The cotter pins are in a zip lock bag in the hardware box.
- Cap the top end of each stud with a provided rubber cap.

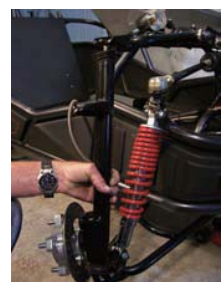

# SET-UP INSTRUCTIONS

## INTERCEPTOR GTR 250

### 6. STEERING LINKAGE

- Attach each tie-rod end to the struts by inserting the ball joint studs into the steering arm of each strut.
- On each stud place flat washer, lock washer, tighten with 17mm wrench and **lock with cotter pin and needle nose pliers.**



### 7. FRONT BRAKE CALIPER

- Slide each brake caliper over the brake discs and align the mounting holes with those of each strut.
- Tighten bolts with a 10mm wrench.

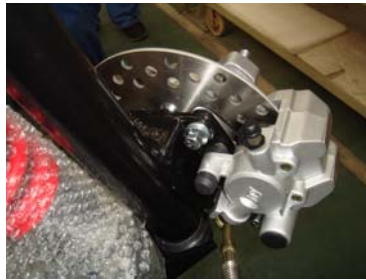

### 8. FRONT WHEEL AND CAP

- In the hardware box you will find 4 chrome wheel caps. The smaller set will be used on the front. Also get out 8 acorn shaped lug nuts.
- Slide the wheel cap into the center hole of the wheel from the back.
- Place the wheel assembly into position by aligning the holes in the wheel with the lugs on the front hubs.
- Tighten the lug nuts with a 15mm socket. With the wheels off the ground you may not be able to tighten the lugs completely. **Lower the kart and tighten the lug nuts completely.**



### 9. HEAD LIGHT

- Place the front head lights in their mounts. Each mount is on either side of the front hood.
- Tighten with 10mm and 12mm wrench.



### 10. REAR BOTTOM A-ARMS

- Place the floor jack under the rear of the unit and lift off the ground.
- The rear bottom a-arm is the large a-arm without shock mounts.
- Insert bottom a-arms into bottom rear suspension mounts with the grease fittings pointing downwards.

**Finger tighten only.**

It is easier to assemble the rear suspension without the bolts tight.



# SET-UP INSTRUCTIONS

## INTERCEPTOR GTR 250

### 11. CV SHAFT

- Slide the female end of each CV shaft over the male end of each side of the center axle.
- Lock into place with lock ring. The lock ring should already be in place on each end of the center axle.

### 12. REAR TOP A-ARMS

- Insert top a-arms into top rear suspension mounts with the grease fittings pointing upwards. The top a-arms have shock mounts on them.
- Finger tighten only.**



### 13. REAR KNUCKLE

- Connect the rear knuckle to the rear suspension by inserting the outer ends of each a-arm into the top and bottom of the knuckle.
- Insert top and bottom bolt of the knuckle.
- With all suspension bolts in place tighten with 14mm and 17mm wrench.**



### 14. REAR SHOCKS

- Place the bottom eye hole of the shock into the shock mounts on the top a-arms and insert bolt.
- Place the top eye hole of the shock into the shock mount located on the frame and insert bolt.
- Tighten bolts with 15mm and 17mm wrench



### 15. REAR WHEEL AND CAP

- In the hardware box you will find 4 chrome wheel caps. The larger set will be used on the rear. Also get out 8 acorn shaped lug nuts.
- Slide the wheel cap into the center hole of the wheel from the back.
- Place the wheel assembly into position by aligning the holes in the wheel with the lugs on the front hubs.
- Tighten the lug nuts with a 15mm socket. With the wheels off the ground you may not be able to tighten the lugs completely. **Lower the kart and tighten the lug nuts completely.**



# SET-UP INSTRUCTIONS

## INTERCEPTOR GTR 250

### 16. STUMP GUARD AND TRAILER HITCH

- Place the stump guard under the rear suspension box/ under the rear sprocket.
- Align the 4 holes of the stump guard with the holes on the frame.
- Be sure all bolts are in place** then tighten with 10mm and 12mm wrench.
- Place trailer hitch plate under trailer hitch mount. Align the 2 bolt holes, insert the 2 large bolts and washers and tighten with a 19mm and 21 mm wrench.
- Tighten ball with 24mm or adjustable wrench.



### 17. CARGO RACK

- Place a black rubber end cap on each mounting post of the cargo rack. There will be 6 in all. The black rubber end caps are in the hardware box. Also remove 6 black anodized bolts and washers.
- Hold the top section of the rack about 1" off the rear frame and start the rear bolts. Go ahead and tighten these rear bolts most of the way. This will prevent the heads of the bolts from scratching the frame.
- Insert the remaining bolts and washers and tighten with a 10mm wrench. **Be sure all bolts are started before tightening.**



### 18. TAIL LIGHT

- Insert the mounting bolts of the tail light into the tail light bracket located under the cargo rack.
- Tighten with a 10mm wrench. **Be sure not to over tighten.**



### 19. FRONT FENDERS

- Place the fender brackets over each strut above the steering arm.
- Start each bolt first** then tighten with a 10mm and 12mm wrench.



# SET-UP INSTRUCTIONS

## INTERCEPTOR GTR 250

### 20. REAR FENDERS

- a. Behind each seat is a mounting post for the rear fenders.
- b. Align the holes and slots of the fender bracket with those of the mounting post.
- c. Tighten with 10mm wrench.



### 21. SEATS AND SEAT BELTS

- a. Remove the seat hardware from the hardware box. This will be the silver bolts, nuts and washers.
- b. The seat belts are shipped bolted together. It is easier to install the seat belts with them separated.
- c. Start on the driver side by bolting the outer end of the seat belt to the seat belt mount located behind the driver seat and in front of the rear fender.
- d. With the driver seat turned upside down, slide the seat adjusters all the way back.
- e. Put the seat in place by aligning the front brackets and rear holes.
- f. Insert a bolt in each hole from *top to bottom* leaving the head of the bolt in the seat adjuster track.
- g. You will have to hold the top of the bolt with a flat head screw driver. Wedge the flat head screw driver between the bolt head and the seat adjuster track and tighten with a 12mm wrench.
- h. Feed the seat belt through the holes in the top of the seat.
- i. Bolt the top seat belt bracket to the seat belt mount located directly behind the drivers head.
- j. Follow the same steps with the passenger seat. The bolts for the passenger seat will be inserted from bottom to top because the passenger seat does not have an adjuster.
- k. Tighten the passenger seat bolts with a 10mm wrench.
- l. Tighten the seat belt bolts with a 14mm and 19mm wrench.



# SET-UP INSTRUCTIONS

## INTERCEPTOR GTR 250

### 22. BRUSH BARS

- Place the main bars in proper location by inserting the open ends over the bar mount posts on the frame. The bar mounting posts for the main bars are at the hood and behind the seat.
- From the hardware box remove the remaining black anodized bolts, washers and lock nuts.
- On each end of the main bar cage place 1 bolt, 2 washers and 1 lock nut. ***Finger tighten only. Do not tighten any bolts for the brush bars until all bolts are in place.***
- Place each shoulder bar over the shoulder bar mount posts on the frame. These posts are on each arm rest.
- Align the top of the shoulder bars with the holes in the main bars and insert bolt and washer and finger tighten. At the bottom of each shoulder bar insert 1 bolt, 2 washers and 1 lock nut and finger tighten.
- Place the top cross-bar between the main bars with hoop pointing towards the front of the kart. Align holes of the top cross bar with holes in the main bars.
- Insert a bolt and washer in each hole and finger tighten.
- Place the bottom cross-bar between the main bars toward the rear of the kart just above the back of the seats. Align holes of the bottom cross-bar with the holes in the main bars.
- Insert a bolt and washer in each hole and finger tighten.
- With all members of the brush bar in place, tighten with a 10mm and 12mm wrench.**



### 23. REAR VIEW MIRROR

- From the hardware box remove the rear view mirror. The rear view mirror will be in a small white box.
- With a Phillips head screw driver, remove the screw in the mounting hole of the mirror.
- Remove black metal clip and discard.



Phillips head screw

Black metal clip



- From the white box remove the chrome spacer and Phillips head screw.

# SET-UP INSTRUCTIONS

## INTERCEPTOR GTR 250

### 24. BATTERY

- a. Put on protective gloves
- b. Remove red strip covering acid ports from battery.
- c. Place funnel into acid ports on battery. Press acid container firmly into funnel allowing acid to flow into battery.
- d. Let acid settle in battery for about 10 minutes.
- e. Place black cap into acid ports and press firmly to secure.
- f. Let battery charge on 15A for about 30 minutes.
- g. Remove electric box cover from behind driver seat.
- h. Place battery into electric box.
- i. Place rectangular nuts under each pole of the battery.
- j. Bolt the green cable to the – pole and the red cable to the + pole.
- k. Secure battery with rubber strap and reinstall electric box cover.



### 25. ENGINE OIL

- a. Remove the dipstick from engine and wipe clean
- b. Place the dipstick back into engine but **do not** overtighten.
- c. Remove dipstick and check oil level.
- d. If oil does not cover the marked portion of the dipstick, add oil.
- e. The engine holds approximately 1.2 liters.





# SET-UP INSTRUCTIONS

## INTERCEPTOR GTR 250

### 26. FILLING THE COOLING SYSTEM WITH COOLANT

*It is very important that you do not just fill the radiator and reservoir with coolant and begin to ride the unit. The cooling system MUST have all the air bled from it or the system will not cool the engine.*

- a. Remove the radiator filler cap and by-pass hose from the by-pass valve.

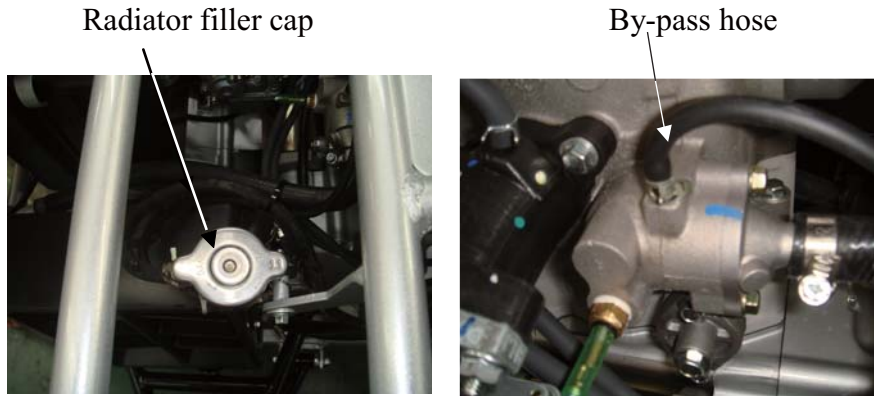

- c. Press hose and let the air out.



- c. With the engine running at idle fill the radiator with coolant. Fill the radiator until coolant comes out of the by-pass valve. When ONLY coolant comes out of the by-pass valve and there are no air bubbles in the coolant, reconnect the by-pass hose.



- d. Continue to fill the radiator until the coolant level reaches the top of the radiator neck where the cap goes. After several minutes of idling the coolant level will drop. Refill the radiator to the same level and monitor for several more minutes for air bubbles. If the coolant level drops again, refill. Once the coolant level is stable and you no longer see air bubbles, screw the radiator cap back on and fill the reservoir to the appropriate level.





**Carter Brothers Manufacturing, Co. , Inc.**

1871 U.S. Highway 231 South

Brundidge, Alabama 36010

Phone: 800-523-5278

[www.carterbro.com](http://www.carterbro.com)