

Hammerhead Off-Road®



POLARIS® and HAMMERHEAD® are trademarks of POLARIS Industries Inc.

Copyright 2018 Polaris Industries Inc. All information contained within this publication is based on the latest product information at the time of publication. Due to constant improvements in the design and quality of production components, some minor discrepancies may result between the actual vehicle and the information presented in this publication. Depictions and/or procedures in this publication are intended for reference use only. No liability can be accepted for omissions or inaccuracies. Any reprinting or reuse of the depictions and/or procedures contained within, whether whole or in part, is expressly prohibited.

The original instructions for this vehicle are in English. Other languages are provided as translations of the original instructions.

Printed in China

9929665

Introduction	5
Safety	9
Features and Controls	23
Operation	31
Emission Control Systems	43
Maintenance	45
Specifications	81
Troubleshooting	87
Warranty	91
Maintenance Log	101

INTRODUCTION

SAFETY SYMBOLS AND SIGNAL WORDS

The following signal words and symbols appear throughout this manual and on your vehicle. Your safety is involved when these words and symbols are used. Become familiar with their meanings before reading the manual.

DANGER

DANGER indicates a hazardous situation which, if not avoided, **WILL** result in death or serious injury.

WARNING

SAFETY ALERT WARNING indicates a hazardous situation which, if not avoided, **COULD** result in serious injury.

CAUTION

SAFETY ALERT CAUTION indicates a hazardous situation which, if not avoided, **COULD** result in minor to moderate injury.

CAUTION

CAUTION indicates special precautions that must be taken to avoid vehicle damage or property damage.

IMPORTANT

IMPORTANT provides key reminders during disassembly, assembly, and inspection of components.

NOTICE

NOTICE provides key information by clarifying instructions.



The Prohibition Safety Sign indicates an action **NOT** to take in order to avoid a hazard.



The Mandatory Action Sign indicates an action that **NEEDS** to be taken to avoid a hazard.

HAMMERHEAD WARNING

WARNING

Failure to heed the warnings and safety precautions contained in this manual can result in severe injury or death. Your HAMMERHEAD vehicle is not a toy and can be hazardous to operate. This vehicle handles differently than cars, trucks or other off-road vehicles. A collision or rollover can occur quickly, even during routine maneuvers like turning, or driving on hills or over obstacles, if you fail to take proper precautions.

- Read this owner's manual. Understand all safety warnings, precautions and operating procedures before operating the vehicle. Keep this manual with the vehicle.
- This vehicle is an ADULT VEHICLE ONLY. You MUST be at least age 16 and have a valid driver's license to operate this vehicle.
- No person under the age of 12 may ride as a passenger in this vehicle. All riders must be able to sit with backs against the seat and both hands on the steering wheel (if driving) or on a passenger hand hold.
- Always keep hands, feet and all other body parts inside the vehicle at all times.
- Always wear a helmet, eye protection, gloves, long-sleeve shirt, long pants and over-the-ankle boots.
- Do not operate this vehicle at night or during periods of limited visibility.
- Never use this vehicle with drugs or alcohol, as these conditions impair judgment and reduce operator reaction time.
- Complete the steps outlined in the New Operator Driving Procedures section. Never allow a guest to operate this vehicle until the guest has watched the instructional video and has completed the New Operator Driving Procedures.

VEHICLE IDENTIFICATION NUMBERS

Record your vehicle's identification numbers in the spaces provided. Remove the spare key and store it in a safe place.



- ① Vehicle Identification Number (GTS/Platinum-on frame behind driver seat, LE-under right rear fender near top of shock)
- ② Engine Serial Number (on engine case and air filter)
- ③ Manufacturing Data Label (on driver side floorboard)
- ④ LE-Model Vehicle Identification Number (passenger side under fender)

Vehicle Model Number:	
Vehicle Identification Number (VIN):	
Engine Serial Number:	
Key Number:	

SAFETY

EQUIPMENT MODIFICATIONS

Your HAMMERHEAD vehicle is designed to provide safe operation when used as directed.

 **WARNING**

Modifying this vehicle in any way can change the top speed, stability and handling performance of this vehicle. Modifications that increase speed, decrease stability or change performance may present a greater risk to inexperienced or younger operators and could result in loss of control and serious injury or death. Use only HAMMERHEAD-approved accessories to modify this vehicle. Review all vehicle changes prior to operating.

The HAMMERHEAD limited warranty on your HAMMERHEAD vehicle will be terminated if any non-HAMMERHEAD-approved equipment and/or modifications have been added to the vehicle that increase speed or power.

SAFETY

SAFE RIDING GEAR

Always wear helmet, eye protection, gloves, long-sleeve shirt, long pants, over-the-ankle boots and seat belt (if equipped) at all times. Protective gear reduces the chance of injury.

RIDER COMFORT

Under certain operating conditions, heat generated by the engine and exhaust system can elevate temperatures in the rider cab area.

The condition occurs most frequently when a vehicle is being operated in high ambient temperatures at low speeds and/or high load conditions for an extended period of time. The use of certain windshield, roof and/or cab systems may contribute to this condition by restricting airflow. Any discomfort due to heat buildup in this area can be minimized by wearing proper riding apparel and by varying speeds to increase airflow.

- ① Helmet
- ② Eye Protection
- ③ Long Sleeves
- ④ Gloves
- ⑤ Long Pants
- ⑥ Over-the-Ankle Boots



CLOTHING

Wear long sleeves and long pants to protect arms and legs.

HELMET

Wearing a helmet can prevent a severe head injury. Whenever riding this HAMMERHEAD vehicle, always wear a helmet that meets or exceeds established safety standards. Clasp the buckle and pull each strap tight to ensure the helmet is properly secured to the head.

Parents should verify that young operators have a helmet that fits, and should obtain one of proper size if it does not fit before allowing operation.

Approved helmets in the USA and Canada bear a U.S. Department of Transportation (DOT) label.



Approved helmets in Europe, Asia and Oceania bear the ECE 22.05 label. The ECE mark consists of a circle surrounding the letter E, followed by the distinguishing number of the country which has granted approval. The approval number and serial number will also be displayed on the label.

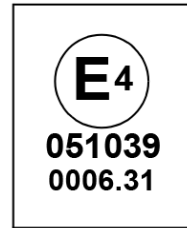

EYE PROTECTION

Do not depend on eyeglasses or sunglasses for eye protection. Whenever riding this HAMMERHEAD vehicle, always wear shatterproof goggles or use a shatterproof helmet face shield. HAMMERHEAD recommends wearing approved Personal Protective Equipment (PPE) bearing markings such as VESC 8, V-8, Z87.1, or CE. Make sure protective eye wear is kept clean.

GLOVES

Wear gloves for comfort and for protection from sun, cold weather and other elements.

BOOTS

Wear sturdy over-the-ankle boots for support and protection. Never ride a HAMMERHEAD vehicle with bare feet or sandals.

SAFETY WARNINGS

WARNING

Failure to operate this vehicle properly can result in a collision, loss of control, accident or rollover, which may result in serious injury or death. Heed all safety warnings outlined in this section of the owner's manual and in the safety DVD provided with your vehicle.

Be sure to read all of the following warnings about driving hazards and how to avoid them. These warnings are provided for your child's safety. Be sure to explain to your young driver that the hazards outlined in this section of this owner's manual **MUST** be avoided at all times. See the OPERATION section of this owner's manual for proper operating procedures.

FOR MORE INFORMATION ABOUT SAFETY call POLARIS at 1-800-342-3764.

OPERATING WITHOUT INSTRUCTION

Operating this vehicle without proper instruction increases the risk of an accident. The operator and the supervising adult must understand how to operate the vehicle properly in different situations and on different types of terrain.

All operators must read and understand this owner's manual and all warning and instruction labels before operating the vehicle. Never allow a guest to operate this vehicle until the guest has read this manual and all product labels.

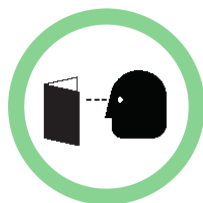

OPERATOR RESTRICTIONS / AGE RESTRICTIONS

This vehicle is an **ADULT VEHICLE ONLY**. Operation is prohibited for anyone under 16 years of age or anyone without a valid driver's license.

Never operate with a passenger under the age of 12. All riders must be able to sit with backs against the seat, both feet flat on the floor and both hands on the steering wheel (if driving) or on a passenger hand hold.



RIDER HEIGHT

Some riders may be too tall to ride safely in this vehicle. Do not operate or ride in this vehicle if the clearance between the top of your helmet and the overhead cab frame is **less than 2 inches (5 cm)**.



SEAT BELTS

Riding in this vehicle without wearing the seat belt increases the risk of serious injury in the event of rollover, loss of control, other accident or sudden stop. Seat belts may reduce the severity of injury in these circumstances. Riders *must* wear seat belts at all times. Always make sure the seat belts are secured for both the operator and passenger before riding.

USING ALCOHOL OR DRUGS

Operating this vehicle after consuming alcohol or drugs could adversely affect operator judgment, reaction time, balance and perception.

Never consume alcohol or drugs before or while operating this vehicle.



FAILURE TO INSPECT BEFORE OPERATING

⚠ WARNING

Failure to inspect and verify that the vehicle is in safe operating condition before operating increases the risk of an accident.

Always perform the pre-ride inspection before each use of your vehicle to make sure it's in safe operating condition.

Always follow the inspection and maintenance procedures and schedules described in this manual.

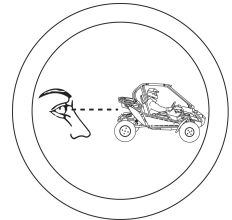

SAFETY

PROTECTIVE APPAREL

Riding in this vehicle without wearing an approved helmet and protective eye wear increases the risk of a serious injuries in the event of an accident. Operator and passenger must always wear an approved helmet that fits properly and eye protection (goggles or face shield).



CARRYING A PASSENGER

Never carry a passenger until you have operated this vehicle for at least four hours and have completed the steps in the New Operator Driving Procedures.

CARRYING MULTIPLE PASSENGERS

A passenger must always be seated in a passenger seat with seat belt secured. Carrying more than one passenger in this vehicle can affect the operator's ability to steer and operate the controls, which increases the risk of loss of control and accident or rollover. Never carry more than one passenger in this vehicle.



OPERATING ON PAVEMENT

This vehicle's tires are designed for off-road use only, not for use on pavement. Operating this vehicle on paved surfaces (including sidewalks, paths, parking lots and driveways) may adversely affect the handling of the vehicle and may increase the risk of loss of control and accident or rollover. Avoid operating the vehicle on pavement. If it's unavoidable, travel slowly, travel short distances and avoid sudden turns or stops.

OPERATING ON PUBLIC ROADS

Operating this vehicle on public streets, roads or highways could result in a collision with another vehicle. Never operate this vehicle on any public street, road or highway, including dirt and gravel roads (unless designated for off-highway use).



OPERATING AT EXCESSIVE SPEEDS

Operating this vehicle at excessive speeds increases the operator's risk of losing control. Always operate at a speed that's appropriate for the terrain, the visibility and operating conditions and your skills and experience.

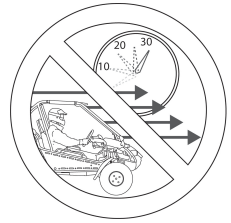

TURNING IMPROPERLY

Turning improperly could cause loss of traction, loss of control, accident or rollover. Always follow proper procedures for turning as described in this owner's manual.

Avoid sharp turns. Never turn while applying heavy throttle. Never make abrupt steering maneuvers. Practice turning at slow speeds before attempting to turn at faster speeds.

JUMPS AND STUNTS

Exhibition driving increases the risk of an accident or rollover. DO NOT do power slides, "donuts", jumps or other driving stunts. Avoid exhibition driving.

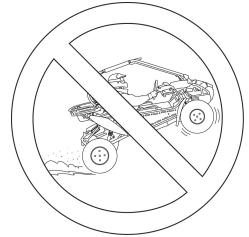

CROSSING HILLSIDES

Driving on a sidehill is not recommended. Improper procedure could cause loss of control or rollover. Avoid crossing the side of any hill unless absolutely necessary.

If crossing a hillside is unavoidable, always follow proper procedures as described in this owner's manual.

PHYSICAL CONTROL OF THE VEHICLE

Removing hands from the steering wheel or hand holds or removing feet from the floor while riding increases the risk of loss of control and accident or rollover.

The operator should always keep both hands on the steering wheel during operation. A passenger should always be seated in the passenger seat with both feet on the floor and with both hands securely grasping the hand holds.

Always keep hands and feet inside the vehicle at all times.

SAFETY

DRIVING DOWNHILL IMPROPERLY

Driving down a hill improperly could cause loss of control or rollover. Always follow proper procedures for driving down a hill as described in this owner's manual.

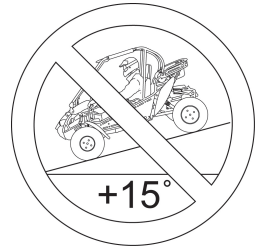

IMPROPER HILL CLIMBING

Improper hill climbing could cause loss of control or rollover. Use extreme caution when operating on hills. Always follow proper procedures for hill climbing as described in this owner's manual. Never operate the vehicle on hills steeper than 15 degrees.

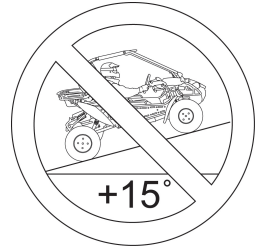

STALLING WHILE CLIMBING A HILL

Stalling or rolling backwards while climbing a hill could cause a rollover. Maintain a steady speed when climbing a hill.

If you lose all forward speed:

Apply the brakes gradually until the vehicle is fully stopped. Place the transmission in reverse and slowly allow the vehicle to roll straight downhill while applying light brake pressure to control speed.

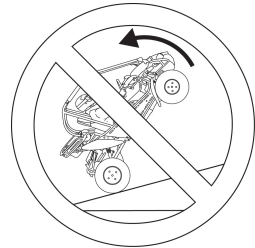

OPERATING IN UNFAMILIAR TERRAIN

Failure to use extra caution when operating on unfamiliar terrain could result in an accident or rollover. Unfamiliar terrain may contain hidden rocks, bumps, or holes that could cause loss of control or rollover.

Travel slowly and use extra caution when operating on unfamiliar terrain. Always be alert to changing terrain conditions.



OPERATING ON SAND OR SLIPPERY TERRAIN

Operating on sand or on excessively rough, slippery or loose terrain could cause loss of traction, loss of control, accident or rollover.

Always use extra caution when operating on sand or on rough, slippery or loose terrain. Do not operate on excessively rough, slippery or loose terrain.



OPERATING IMPROPERLY IN REVERSE

Improperly operating in reverse could result in a collision with an obstacle or person. Always follow proper operating procedures as outlined in this manual.

Before shifting into reverse gear, always check for obstacles or people behind the vehicle. When it's safe to proceed, back slowly.

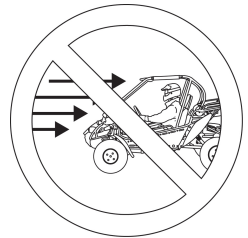

OVERLOADING THE VEHICLE

Overloading the vehicle or carrying/towing loads may cause changes in stability and handling, which could cause loss of control or an accident.

- Never tow objects or carry loads with this vehicle.
- Never exceed the maximum weight capacity for this vehicle.

OPERATING OVER OBSTACLES

Improperly operating over obstacles could cause loss of control or rollover.

Before operating in a new area, check for obstacles. Avoid operating over large obstacles such as large rocks and fallen trees. Always follow the proper procedures outlined in this manual when operating over obstacles.



SAFETY

OPERATING THROUGH WATER

Operating through deep or fast-flowing water can cause loss of traction, loss of control, rollover or accident. Never operate in fast-flowing water or in water that exceeds the floor level.

Always follow proper procedures for operating in water as described in this owner's manual.

Wet brakes may have reduced stopping ability. After leaving water, test the brakes. Apply them lightly several times while driving slowly. The friction will help dry out the pads.



OPERATING ON FROZEN BODIES OF WATER

Operating on frozen bodies of water can result in the vehicle and/or riders falling through the ice. Never operate this vehicle on a frozen body of water.



IMPROPER TIRES AND MAINTENANCE

Operating this vehicle with improper tires or with improper or uneven tire pressure could cause loss of control, accident or rollover.

Always use the size and type of tires specified for your vehicle. Always maintain proper tire pressure as described in this owner's manual and on safety labels.

OPERATING A DAMAGED VEHICLE

Operating a damaged vehicle can result in an accident. After any rollover or other accident, have a qualified service dealer inspect the entire machine for possible damage, including (but not limited to) seat belts, rollover protection devices, brakes, throttle and steering systems.

REFUELING

Gasoline is highly flammable and is explosive under certain conditions. Always exercise extreme caution whenever handling gasoline.

- Never allow a child to refuel or handle gasoline.
- Never carry fuel or other flammable liquids on this vehicle. Failure to follow this instruction could lead to serious injury or death.
- Always stop the engine when refueling.
- Always refuel outdoors or in a well ventilated area.
- Do not smoke or allow open flames or sparks in or near the refueling area or where gasoline is stored.
- Never refuel while a person is in the vehicle.
- Do not over fill the tank. Do not fill the tank neck.
- If gasoline spills on your skin or clothing, immediately wash it off with soap and water and change clothing.

EXPOSURE TO EXHAUST

Engine exhaust fumes are poisonous and can cause loss of consciousness or death in a short time. Never start the engine or let it run in an enclosed area. Operate this vehicle only outdoors or in well-ventilated areas.

HOT EXHAUST SYSTEMS

WARNING

Exhaust system components are very hot during and after use of the vehicle. Hot components can cause burns and fire. Do not touch hot exhaust system components. Always keep combustible materials away from the exhaust system.

Use caution when traveling through tall grass, especially dry grass. Always inspect the underside of the vehicle and areas near the exhaust system after driving through tall grass, weeds, brush and other tall ground cover. Promptly remove any grass or debris clinging to the vehicle.

UNAUTHORIZED USE OF THE VEHICLE

Leaving the keys in the ignition can lead to unauthorized use of the vehicle by someone under the age of 16 or without proper training. This could result in an accident or rollover. Always remove the ignition key when the vehicle is not in use.

SAFETY

SAFETY LABELS AND LOCATIONS

Warning labels have been placed on the vehicle for your protection. Read and follow the instructions on each label carefully. If any of the labels shown in this manual differ from the labels on your vehicle, always read and follow the instructions of the labels on the vehicle.

If an informational or graphic label becomes illegible or comes off, contact your HAMMERHEAD dealer to purchase a replacement. Replacement safety labels are provided by HAMMERHEAD at no charge.

WARNING

This go-kart can be hazardous to operate if driven carelessly. Injuries can result if you do not follow these instructions:

- Read owner's manual and all labels before you operate this go-kart.
- Never operate this go-kart without proper instructions. Beginners require adult supervision.
- Never operate this go-kart on public roads. It is intended for off-road use only.
- Always wear an approved motorcycle helmet, eye protection and protective clothing.
- Never operate this go-kart at excessive speeds. You increase your risk of losing control if you operate it at speeds too fast for the terrain, visibility conditions or your experience.
- Never attempt wheelies, jumps, or other stunts.

WARNING

NO LONG HAIR

All hair must be tied up and secured at or above shoulder length. All loose clothing must be secured. All necklaces and scarves must be secured.



⚠ WARNING

Loss of control, collision, or getting caught in moving parts can result in serious injuries.

- No operation under age of 16 allowed.
- Wear a D.O.T. approved motorcycle helmet.
- Secure long hair and loose clothing.
- Wear protective eye wear and clothing.
- Keep arms, legs and feet inside kart.
- Do not use alcohol or drugs.

⚠ WARNING

- Moving parts can crush and cut.
- Keep hands clear.
- Do not operate with guards removed.

**⚠ WARNING**

Seat belt must be worn at all times.

CAUTION

This vehicle manufactured for off-road use only. Do not operate on public streets, roads, or highways.

⚠ WARNING

No Riding.



FEATURES AND CONTROLS COMPONENT LOCATIONS



- ① Headlights
- ② Brush Guards
- ③ Cargo Box
- ④ Hip Bars

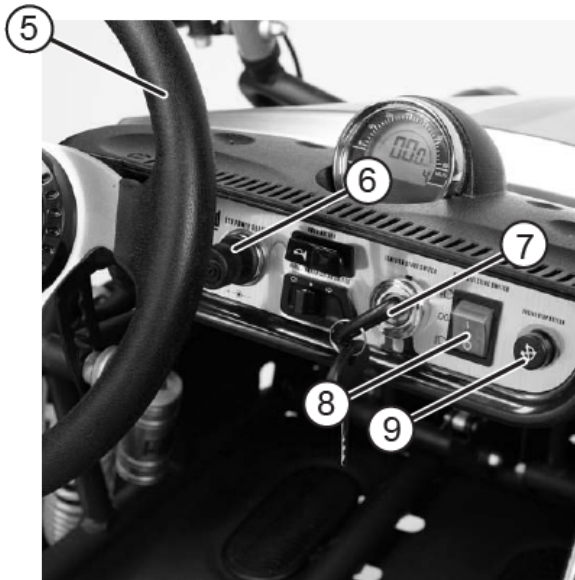

- ⑤ Steering Wheel
- ⑥ 12 V Aux Output
- ⑦ Ignition Start Switch
- ⑧ Headlamp Beam Selection Switch
- ⑨ Ignition Stop Button

FEATURES AND CONTROLS

SEATS

DRIVER'S SEAT ADJUSTMENT

1. Lift the seat latch lever located under the left front edge of the driver's seat.
2. While holding the lever upward, slide the seat forward or rearward to the desired position, then release the lever.
3. Slide the seat forward and rearward to ensure the latch is engaged. Before operating the vehicle, always make sure both seats are securely installed.

STEERING WHEEL

The steering wheel can be adjusted upward or downward for rider preference.

1. Loosen the steering wheel adjustment bolt ①.
2. Move the steering wheel upward or downward to the desired position.
3. Hand-tighten the bolt.



SEAT BELTS

This HAMMERHEAD vehicle is equipped with seat belts for all riders. Always make sure the seat belts are secured for the operator and passenger before riding.

5-POINT SEAT BELT

To wear the 5-point seat belt properly, do the following:

1. Sit in the seat and place the shoulder belts over your shoulders. Make sure the belts are not twisted. Push the latch plates into buckle until it clicks.
2. Secure the two lap belts. Push the latch plates into the buckle until they click. Pull up on the strap to tighten. Then, attach the latch plate between legs. Push the latch plate into the buckle until it clicks. Pull up on the strap to tighten.

RACING-STYLE SEAT BELT (IF EQUIPPED)

To wear the racing-style seat belt properly, do the following:

1. Sit in the seat and place the shoulder belts over your shoulders. Make sure the belts are not twisted.
2. Take the left latch plate and thread it through the belt plates in the following order: left shoulder belt, center lap belt, right shoulder belt.
3. Push the latch plate into the buckle on the right lap belt until it locks. Pull on straps to tighten.

SEAT BELT INSPECTION

Inspect all seat belts for proper operation before each use of the vehicle.

1. Push the latch plate into the buckle until it clicks. The latch plate must slide smoothly into the buckle. A click indicates that it's securely latched.
2. Push the red release latch in the middle of the buckle to make sure it releases freely.
3. Pull each seat belt completely out and inspect the full length for any damage, including cuts, wear, fraying or stiffness. If any damage is found, or if the seat belt does not operate properly, have the seat belt system checked and/or replaced by an authorized dealer.
4. To clean dirt or debris from the seat belts, sponge the straps with mild soap and water. Do not use bleach, dye or household detergents.

SWITCHES

IGNITION SWITCH (LE-MODELS ONLY)

The ignition switch is a three-position, key-operated switch. Use the ignition switch to start the engine. See the Starting the Engine section for starting procedures.

The key can be removed from the switch when it is in the OFF position.

		
OFF	ON	START
The engine is off. Electrical circuits are off, except accessory 12V.	Electrical circuits are on. Electrical equipment can be used.	Turn the key to the START position to engage the electric starter. The key returns to the ON position when released.

FEATURES AND CONTROLS

IGNITION SWITCH (NON-LE MODELS)

The ignition switch is a three-position, key-operated switch. The key can be removed from the switch when it is in the OFF position.

OFF	The engine is off. Electrical circuits are off, except Acc, 12V.
ON	Electrical circuits are on. Electrical equipment can be used.
START	Turn the key to the START position to engage the electric starter. The key returns to the ON position when released.

LIGHT SWITCH

The ignition switch key must be in the ON/RUN position to operate the headlights. Press the TOP of the rocker switch toward the dash to turn the headlights on. Press the BOTTOM of the rocker switch to turn off the headlights.

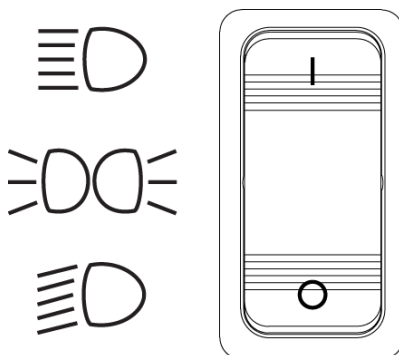

STOP ENGINE SWITCH (LE MODELS ONLY)

The stop engine switch shuts down the engine. The switch must be in the ON/ TOP position to operate the vehicle.

Before driving the vehicle, test the Engine Stop Switch to assure that it operates properly. With the engine running, press the BOTTOM of the switch to shut off the engine.



STOP ENGINE BUTTON (NON-LE MODELS)

The stop engine button shuts down the engine. Press button in and hold for 2 seconds to shut down engine.

Before driving this vehicle, test the Engine Stop Button to assure that it operates properly. With the engine running, push and hold the Engine Stop Button for two seconds for the engine to shut down.

AUXILIARY OUTLET

The vehicle is equipped with a 12-volt accessory outlet on the dash. Use the outlet to power an auxiliary light or other optional accessories or lights. For service, the dash outlet connection is under the dash.

HORN (NON-LE MODELS)

The vehicle is equipped with a horn. To use, press in on horn button.

GEAR SELECTOR

F: Forward

N: Neutral

R: Reverse

The gear selector^① is located between the seats. To change gears, stop the vehicle, and with the engine idling, move the lever to the desired gear. Do not attempt to shift gears with engine speed above idle or while the vehicle is moving.

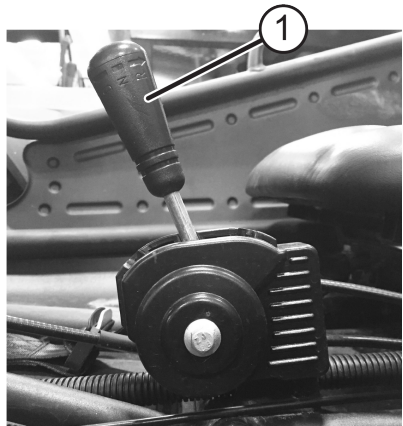

TIP

Maintaining shift linkage adjustment is important to assure proper transmission function. Your authorized dealer can assist in resolving any shifting problems.

NOTICE

Do not attempt to shift the transmission while the vehicle is moving or damage to the transmission could result. Always shift when the vehicle is stationary and the engine is at idle.

FEATURES AND CONTROLS

BRAKE PEDAL

Depress the brake pedal to slow or stop the vehicle. Apply the brakes while starting the engine.

THROTTLE PEDAL

Push the throttle pedal^① down to increase engine speed. Spring pressure returns the pedal to the rest position when released. Always check that the throttle pedal returns normally before starting the engine. Make sure there's adequate throttle pedal freeplay. See the Throttle Freeplay Adjustment section for throttle pedal adjustment procedures.



PARKING BRAKE

1. Apply the brakes.
2. When the vehicle is fully stopped, pull the parking brake lever REARWARD as far as possible to set the parking brake.
3. Stop the engine.
4. To release the parking brake, apply the brakes and push the lever TOWARD the passenger seat and forward.
5. See the Parking Brake Adjustment section for adjustment procedures.

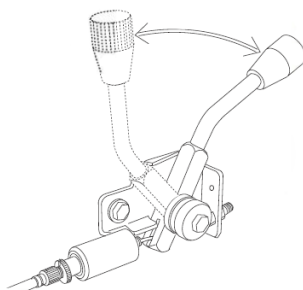

TIP

Always set the parking brake whenever the vehicle is left unattended.

⚠ WARNING

Operating the vehicle while the parking brake is engaged could cause an accident resulting in serious injury or death. It could also result in driveline or engine damage. Always be sure to disengage the parking brake before operating the vehicle.

MECHANICAL SPEED CONTROL SYSTEM

The adjustable throttle limiting screw is located behind the throttle pedal. Use the following procedure to control how far the throttle opens.

1. Remove limiter bolt.
2. Add washers underneath limiter bolt head until desired max speed is reached.

FUEL CAP

The fuel tank filler cap^① is located in the rear of the vehicle, behind the seats.

When refueling, always use unleaded gasoline with a minimum pump octane number of 87 R+M/2 octane. Non-ethanol fuel is recommended. *Do not use fuel with ethanol content greater than 10 percent, such as E-85 fuel.*



OPERATION

WARNING

Failure to operate the vehicle properly can result in a collision, loss of control, accident or rollover, which may result in serious injury or death. Read and understand all safety warnings outlined in the safety section of this owner's manual.

VEHICLE BREAK-IN PERIOD

The break-in period for your new HAMMERHEAD vehicle is defined as the first five (5) hours of operation.

No single action on your part is as important as a proper break-in period. Careful treatment of a new engine and drive components will result in more efficient performance and longer life for these components. Perform the following procedures carefully.

NOTICE

Excessive heat build-up during the first three hours of operation will damage close-fitted engine parts and drive components. Do not operate at full throttle or high speeds during the first three hours of use.

Mixing brands or using a non-recommended oil may cause serious engine damage. Always use the recommended oil. Never substitute or mix oil brands.

ENGINE AND DRIVETRAIN BREAK-IN

1. Fill the fuel tank with gasoline. Always exercise extreme caution whenever handling gasoline. See the Refueling section for details.
2. Check the oil level. See the Oil Check section for details. Add the recommended oil as needed to maintain the oil level in the safe operating range.
3. Complete the steps detailed in the New Operator Driving Procedures section.
4. Avoid aggressive use of the brakes. See Brake System Break-in section for details.
5. Vary throttle positions. Do not operate at sustained idle.
6. Perform regular checks on fluid levels, controls, and areas outlined on in the Pre-Ride Inspection section's checklist.
7. Change the engine oil at five (5) hours.
8. Adjust and lubricate the drive chain at five (5) hours.

OPERATION

BRAKE SYSTEM BREAK-IN

Apply only moderate braking force for the first 50 stops. Aggressive or overly forceful braking when the brake system is new could damage brake pads and rotors.

CVT BREAK-IN (CLUTCHES / BELT)

A proper break-in of the clutches and drive belt will ensure a longer life and better performance. Break in the clutches and belt by operating at slower speeds during the break-in period as recommended. Avoid aggressive acceleration and high speed operation during the break-in period.

PRE-RIDE INSPECTION

Failure to inspect and verify that the vehicle is in safe operating condition before operating increases the risk of an accident. Always inspect the vehicle before each use to make sure it's in safe operating condition.

ITEM	REMARKS	REF.
Brake system/pedal travel	Ensure proper operation	page 28 page 64
Brake fluid	Ensure proper level	page 65
Front suspension	Inspect, lubricate if necessary	page 49
Rear suspension	Inspect, lubricate if necessary	page 49
Steering	Ensure free operation	page 65
Tires	Inspect condition and pressure	page 20 page 67
Wheels/fasteners	Inspect, ensure fastener tightness	page 68
Frame nuts, bolts, fasteners	Inspect, ensure tightness	–
Fuel and oil	Ensure proper levels	page 50
Grass and Debris	Remove grass and debris from the vehicle, especially on the underside and near the exhaust system	–
Throttle	Ensure proper operation	page 62
Indicator lights/switches	Ensure proper operation	–
Air Filter	Inspect and clean or replace	page 61
Daytime running lights	Ensure proper operation	page 70
Brake Light	Ensure proper operation	–

ITEM	REMARKS	REF.
Seat Latches	Move the seats forward and rearward to ensure correct installation	page 24
Seat Belts	Check length of belt for damage, check latches for proper operation	page 24

SAFE OPERATION PRACTICES

1. Visit the Recreational Off-Highway Vehicle Association web site (rohva.org) and take the free on-line training course. Complete the recommended safety training before operating this vehicle.
2. Do not allow anyone under 16 years of age or without a valid driver's license to operate this vehicle.
3. Never operate with a passenger under the age of 12. Never carry more one passenger in a 2-seat vehicle. Never allow a passenger to ride in the cargo box.
4. Engine exhaust fumes are poisonous. Never start the engine or let it run in an enclosed area.
5. Never operate with accessories not approved by HAMMERHEAD for use on this vehicle.
6. Operate this vehicle off-road only. Never operate the vehicle on pavement or on any public street, road or highway, including dirt and gravel roads.
7. Drive in a manner appropriate for your skills and operating conditions. Never operate at excessive speeds. Never attempt wheelies, jumps, or other stunts. Keep both hands on the steering wheel during operation.
8. Never consume alcohol or drugs before or while operating this vehicle.
9. Always use the size and type of tires specified for your vehicle. Always maintain proper tire pressure.
10. Never operate a damaged vehicle. After any rollover or accident, have a qualified service dealer inspect the entire machine for possible damage.
11. Never operate the vehicle on a frozen body of water unless you have first verified that the ice is sufficiently thick to support the weight and moving force of the vehicle, you and your passenger, and your cargo, together with any other vehicles in your party.
12. Do not touch hot exhaust system components. Always keep combustible materials away from the exhaust system.
13. Always remove the ignition key when the vehicle is not in use to prevent unauthorized use.

STARTING THE ENGINE

NOTICE

Operating the vehicle immediately after starting could cause engine damage. Allow the engine to warm up for several minutes before operating the vehicle.

TIP

The choke is fully on when it's pulled out. The choke is off when it's completely pushed in. The choke can be adjusted gradually depending on how much choke is needed for starting.

1. Sit in the driver's seat and fasten the seat belt.
2. Place the transmission in neutral. Set the parking brake.
3. Apply the brakes.
4. If the engine is cold, use full choke by pulling the choke all the way out. A warm engine will not require the use of the choke.
5. Do not press the throttle pedal while starting the engine.
6. **If operating an LE model:** make sure the Engine Stop Switch is in the ON position.
7. Turn the ignition key past the ON/RUN position to START. Engage the starter for a maximum of five seconds. Release the key when the engine starts.
8. If the engine does not start within five seconds, return the ignition switch to the OFF position and wait five seconds. Repeat steps 6 and 7 until the engine starts.
9. Vary the engine RPM slightly with the throttle to aid in warm-up until the engine idles smoothly.
10. Release the parking brake before driving.

STOPPING THE ENGINE

1. Release the throttle pedal completely and brake to a complete stop.
2. Place the transmission in neutral.
3. Set the parking brake.
4. Stop the engine.
5. Turn key to off position

BRAKING

1. Release the throttle pedal completely. (When the throttle pedal is released completely and engine speed slows to near idle, the vehicle has no engine braking).
2. Press on the brake pedal evenly and firmly. Practice starting and stopping (using the brakes) until you're familiar with the controls.

PARKING THE VEHICLE

1. Stop the vehicle on a level surface. When parking inside a garage or other structure, be sure that the structure is well ventilated and that the vehicle is not close to any source of flame or sparks, including any appliance with pilot lights.
2. Place the transmission in neutral.
3. Set the parking brake.
4. Stop the engine.
5. Remove the ignition key to prevent unauthorized use.

NEW OPERATOR DRIVING PROCEDURES

1. Read and understand this owner's manual and all warning and instruction labels before operating this vehicle.
2. Visit the Recreational Off-Highway Vehicle Association web site (rohva.org) and take the free on-line training course. Hands-on training is also available through ROHVA.
3. Review the section of this owner's manual about starting the engine, stopping the engine, braking and parking.
4. Perform the steps outlined in the Pre-Ride Inspection section.
5. The driver and passenger must wear helmet, eye protection, gloves, long-sleeve shirt, long pants, over-the-ankle boots and seat belt at all times.
6. Do not operate or ride in this vehicle if the clearance between the top of your helmet and brush bar is less than 2 inches (5 cm).
7. Select a level open area to practice driving. Make sure you have permission to drive in this area.
8. Sit in the driver's seat and fasten the seat belt.
9. Make sure all passengers secure their seat belts.
10. Do not carry a passenger until you have at least four hours of driving experience with this vehicle.
11. Set the parking brake.

OPERATION

12. Place the transmission in neutral.
13. Start the engine. See the Starting the Engine section for details
14. Apply the brakes and shift into gear.
15. Release the parking brake.
16. Check your surroundings. Make sure the area is clear of people and obstacles.
17. Keeping both hands on the steering wheel, slowly release the brakes and press the throttle with your right foot to begin driving.
18. Drive slowly at first. Practice starting, stopping, turning, using the throttle and brakes and driving in reverse. Learn how the vehicle handles when making both left and right turns at a slow speed.
19. Increase speed only after mastering all maneuvers at a slow speed.
20. After you become skilled at making turns and begin to operate at faster speeds, follow these precautions:
 - Avoid sharp turns. Make turns gradually.
 - Never turn while applying heavy throttle.
 - Never turn the steering wheel abruptly.
 - Operate at speeds appropriate for your skills, the conditions and the terrain.
 - DO NOT attempt to do power slides, “donuts”, jumps or other driving stunts.

DRIVING WITH A PASSENGER

1. Complete the steps outlined in the New Operator Driving Procedures section.
2. Perform the steps outlined in the Pre-Ride Inspection section.
3. Do not carry a passenger until you have at least four hours of driving experience with this vehicle.
4. Make sure the passenger is at least 12 years of age. All riders must be able to sit with backs against the seat, both feet flat on the floor and both hands on the steering wheel (if driving) or on a passenger hand hold
5. Make sure the passenger has at least 2 inches (5 cm) of clearance between his helmet and the brush bars.
6. Never carry more than one passenger in this vehicle.
7. Never allow a passenger to ride on the back of the vehicle. Allow a passenger to ride only in the passenger seat.
8. Make sure the passenger is wearing helmet, eye protection, gloves, long-sleeve shirt, long pants and over-the-ankle boots.

9. Make sure the passenger secures the seat belt.
10. Tell your passenger to always keep hands and feet inside the vehicle at all times.
11. Drive slowly. Vehicle handling may change with a passenger on board. Always travel at a speed appropriate for your skills, your passenger's skills, and operating conditions. Avoid unexpected or aggressive maneuvers that could cause discomfort or injury to a passenger.
12. Always follow all operating guidelines as outlined on safety labels and in this manual.

OPERATION

DRIVING ON SLIPPERY SURFACES

When driving on slippery surfaces such as wet trails, loose gravel, sand or ice, be alert for the possibility of skidding and sliding.

Follow these precautions when driving in slippery conditions:

1. Slow down before entering slippery areas.
2. Be alert, watch the path ahead and avoid quick turns, which can cause skids.
3. Correct a skid by turning the steering wheel in the direction of the skid. *Never apply the brakes during a skid.*

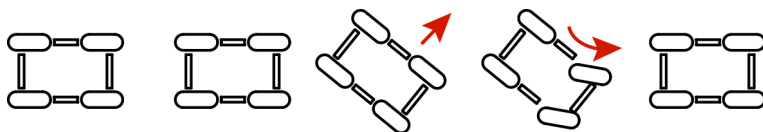

DRIVING UPHILL

Whenever traveling uphill, follow these precautions:

1. Always check the terrain carefully before ascending a hill. Never drive on hills with excessively slippery or loose surfaces.
2. Avoid excessively steep hills (**15° maximum**).

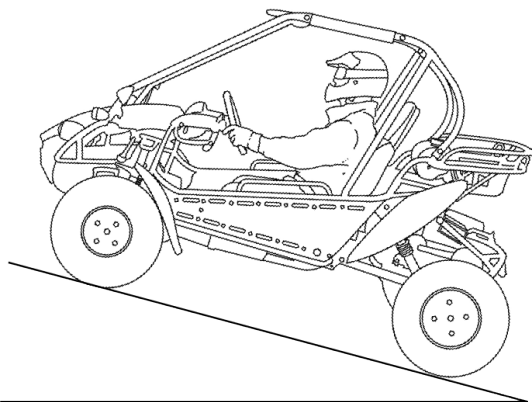

3. Drive straight uphill.
4. Drive at a steady rate of speed. Never press the throttle suddenly.
5. Avoid unnecessary changes in speed or direction.

6. Never go over the crest of a hill at a high speed. An obstacle, a sharp drop, or another vehicle or person could be on the other side of the hill.
7. If the vehicle stalls while climbing a hill, apply the brakes. Place the transmission in reverse and slowly allow the vehicle to roll straight downhill while applying the brakes lightly to control speed.

DRIVING ON A SIDHILL (SIDEHILLING)

Driving on a sidehill is not recommended. Driving on a sidehill improperly cause loss of control or rollover.

If crossing a hill is *unavoidable*, follow these precautions:

1. Drive slowly and use extreme caution.
2. If the vehicle begins to roll over, or if it feels as if it may roll over, *immediately* turn downhill.
3. Avoid obstacles and changes in terrain that may lower or raise one side of the vehicle or cause the vehicle to slide.
4. If the vehicle begins to slide downhill, immediately turn downhill to stop the slide, or stop the vehicle and maneuver slowly and carefully until the vehicle can be driven straight downhill.

DRIVING DOWNHILL

Whenever driving down a hill, follow these precautions:

1. Avoid excessively steep hills (**15° maximum**).
2. Slow down. Never travel down a hill at high speed.
3. Always check the terrain carefully before driving down a hill. Never drive on hills with excessively slippery or loose surfaces.
4. Always drive down a hill with the transmission in forward gear. *Never “coast” or drive down a hill with the transmission in neutral.*
5. Avoid driving down a hill at an angle, which would cause the vehicle to lean sharply to one side. Always drive straight downhill.
6. Apply the brakes *lightly* to keep speed slow.

OPERATION

DRIVING THROUGH WATER

Your vehicle can drive through shallow water. Make sure the water is no deeper than the floor of the vehicle. Follow these precautions when driving through water:

1. Check water depth. Never drive through water that is deeper than the floor level.
2. After driving through water, test the brakes. Apply them lightly several times while driving slowly. The friction will help dry out the pads.

NOTICE

Major engine damage can result if the vehicle is not thoroughly inspected after operation in water. Perform the services outlined in the Periodic Maintenance Chart section. Give special attention to engine oil, transmission oil and all grease fittings.

If your vehicle becomes immersed or is operated in water that exceeds the floor level, service is required before starting the engine. Your HAMMERHEAD dealer can provide this service. If it's impossible to bring the vehicle in before starting the engine, perform the service outlined in the Vehicle Immersion section, and take the vehicle in for service at the first opportunity.

DRIVING IN REVERSE

Follow these precautions when driving in reverse:

1. Always check for obstacles or people behind the vehicle.
2. Apply the throttle lightly. Never apply the throttle suddenly.
3. Back slowly.
4. Apply the brakes lightly for stopping.
5. Avoid making sharp turns.

PARKING ON AN INCLINE

A rolling vehicle can result in serious injury. Avoid parking on an incline. If parking on an incline is *unavoidable*, follow these precautions:

1. Place the transmission in neutral.
2. Set the parking brake.
3. Stop the engine.
4. Always block the rear wheels on the downhill side.

DRIVING OVER OBSTACLES

Follow these precautions when driving over obstacles:

1. Always check for obstacles before driving in a new area.
2. Look ahead and watch the terrain. Always be alert for hazards such as logs, rocks and low hanging branches.
3. Drive slowly and use extra caution when driving on unfamiliar terrain. Obstacles are not always clearly visible.
4. Do not drive over large obstacles such as large rocks and fallen trees. If it's unavoidable, use extreme caution and drive slowly.
5. Always have a passenger dismount and move away from the vehicle before driving over an obstacle that could cause a rollover.

EMISSION CONTROL SYSTEMS

NOISE EMISSION CONTROL SYSTEM

Do not modify the engine, intake or exhaust components, as doing so may affect compliance with U.S.A. EPA noise control requirements (40 CFR 205) and local noise level requirements.

CRANKCASE EMISSION CONTROL SYSTEM

This engine is equipped with a closed crankcase system. Blow-by gases are forced back to the combustion chamber by the intake system. All exhaust gases exit through the exhaust system.

MAINTENANCE

PERIODIC MAINTENANCE CHART

Any qualified repair shop or person may maintain, replace or repair the emission control devices or systems on your vehicle. An authorized HAMMERHEAD dealer can perform any service that may be necessary for your vehicle.

HAMMERHEAD also recommends HAMMERHEAD parts for emissions-related service, however equivalent parts can be used.

It is a potential violation of the Clean Air Act if a part supplied by an aftermarket parts manufacturer reduces the effectiveness of the vehicle's emission controls. Tampering with emission controls is prohibited by federal law.

Owners are responsible for performing the scheduled maintenance identified in this owner's manual.

Careful periodic maintenance will help keep your vehicle in the safest, most reliable condition. Inspection, adjustment and lubrication of important components are explained in the periodic maintenance chart.

Inspect, clean, lubricate, adjust and replace parts as necessary. When inspection reveals the need for replacement parts, genuine HAMMERHEAD parts are available from your HAMMERHEAD dealer. Equivalent parts may be used for emissions-related service.

Record maintenance and service in the Maintenance Log section.

Service and adjustments are important for proper vehicle operation. If you're not familiar with safe service and adjustment procedures, a qualified dealer can perform these operations.

Vehicles subjected to heavy or severe use patterns must be inspected and serviced more frequently.

SEVERE USE DEFINITION

- Frequent immersion in mud, water or sand
- Frequent or prolonged operation in dusty environments
- Short trip cold weather operation
- Racing or race-style high RPM use
- Prolonged low speed, heavy load operation
- Extended idle

Pay special attention to the oil level. A rise in oil level during cold weather can indicate contaminants collecting in the oil sump or crankcase. Change oil immediately if the oil level begins to rise. Monitor the oil level, and if it continues to rise, discontinue use and determine the cause. Your dealer can assist.

MAINTENANCE

MAINTENANCE CHART KEY

SYMBOL	DESCRIPTION
XU	Perform these procedures more often for vehicles subjected to severe use.
D	Have an authorized dealer or other qualified person perform these services.

WARNING

Improperly performing the procedures marked with a **D** could result in component failure and lead to serious injury or death. Have an authorized dealer or other qualified person perform these services.

Perform all services at whichever maintenance interval is reached first. Record maintenance and service in the Maintenance Log.

ITEM		MAINTENANCE INTERVAL (WHICHEVER COMES FIRST)			REMARKS
		HRS	CLNDR	MILES (KM)	
	Steering		Daily		Check each day before driving the vehicle. Make adjustments as needed. See the Pre-Ride Checklist section for details.
	Front suspension				
	Rear suspension				
	Tires				
	Brake fluid level				
	Brake pedal travel				
	Brake system				
	Wheels/fasteners				
	Frame fasteners				
	Engine oil level				
	Fuel Tank		Daily		Add Carbon Clean with each fuel fill
XU	Air filter		Daily		Inspect; clean often; replace as needed
	Airbox Sediment Tube		Daily		Drain when deposits are visible
	Daytime running lights/taillight		Daily		Check operation

MAINTENANCE

ITEM		MAINTENANCE INTERVAL (WHICHEVER COMES FIRST)			REMARKS
		HRS	CLNDR	MILES (KM)	
	Drive chain		Daily		Inspect; adjust, lubricate, replace as needed
	CVT housing (if equipped)		Weekly		Drain water as needed, check often if driving in wet conditions
XU D	Brake pad wear	10	Monthly	100 (160)	Inspect periodically
D	Choke (if equipped)	10	Monthly	100 (160)	Check for proper operation; your dealer can assist
	Idle Speed	10	Monthly	100 (160)	Check, adjust as needed
	Valve Clearance (Initial)	10	Monthly	100 (160)	Valve lash adjustment: Every 40 hours after first 10 hour adjustment
XU	Engine oil change (break-in)	5	Monthly		Perform a Break-in Oil Change at one month
	Drive chain (break-in)	5	Monthly		Adjust and lubricate
	Fuel System	25	Monthly		Inspect; check lines and fittings for leaks and abrasion
	Battery	25	Monthly	250 (400)	Check terminals; clean; test
XU	Main gearcase oil	25	Monthly	250 (400)	Inspect level; change yearly
XU	Engine breather filter (if equipped)	25	1 M	150 (250)	Inspect; replace if necessary
XU	Engine oil change	30	6 M	300 (480)	Change Oil; Use 10w40 (SN) Conventional Engine Oil
XU	General lubrication	50	3 M	500 (800)	Lubricate all fittings, pivots, cables, etc.
	Shift Linkage	50	6 M	500 (800)	Inspect, lubricate, adjust
D	Steering	50	6 M	500 (800)	Lubricate
XU	Front Suspension	50	6 M	500 (800)	Lubricate
XU	Rear Suspension	50	6 M	500 (800)	Lubricate
D	Choke Cable	50	6 M	500 (800)	Inspect; adjust; lubricate; replace if necessary. Your dealer can assist.

MAINTENANCE

ITEM		MAINTENANCE INTERVAL (WHICHEVER COMES FIRST)			REMARKS
		HRS	CLNDR	MILES (KM)	
	Carburetor Float Bowl	50	6 M	500 (800)	Drain bowl periodically, and prior to storage.
	Carb Intake Ducts	50	6 M	500 (800)	Inspect duct for proper sealing/ air leaks
D	Valve Clearane	50		500 (800)	Adjust valve lash every 40 hours after first 10 hours
D	Fuel system/filter	100	12 M	600 (1000)	Inspect; Clean/Replace if necessary. Check for leaks at tank cap, filter, and carburetor.
XU	Spark plug	100	12M	600 (1000)	Check, Replace as necessary, torque to specification
XU	Engine mounts	100	12 M	1000 (1600)	Inspect
	Exhaust muffler/ pipe	100	12 M	1000 (1600)	Inspect
D	Ignition timing	100	12 M	1000 (1600)	Inspect
XU	Wiring	100	12 M	1000 (1600)	Inspect for wear, routing, security; apply dielectric grease to connectors subjected to water, mud, etc.
D	Clutches (drive and driven)	100	12 M	1000 (1600)	Inspect; clean; replace worn parts
	Drive belt	100	12 M	1000 (1600)	Inspect; replace as needed
D	Front wheel bearings	100	12 M	1000 (1600)	Inspect; replace as needed
D	Brake fluid	200	24 M	2000 (3200)	Change every two years
	Spark arrester	300	36 M	3000 (4800)	Clean out
D	Toe adjustment				Inspect periodically; adjust when parts are replaced

LUBRICATION RECOMMENDATIONS

Check and lubricate all components at the intervals outlined in the Periodic Maintenance Chart, or more often under severe use, such as wet or dusty conditions. Items not listed in the chart should be lubricated at the general lubrication interval.

	ITEM	LUBE	REFERENCE
	Engine Oil	10w40 Conventional Engine Oil	page 50
	Brake Fluid	DOT 4 Brake Fluid	page 65
	Transmission Oil (Main Gearcase)	AGL Gearcase Lubricant & Transmission Fluid	page 53
	Drive Chain	Chain Lube or SAE 80/90	page 54
	A-Arm Pivots	All Season Grease or grease conforming to NLGI No. 2	Grease at general lubrication interval, also after washing vehicle or driving in water.
XU	Steering Arm Pivots		

XU - Perform these procedures more often for vehicles subjected to severe use.

MAINTENANCE

ENGINE OIL

OIL RECOMMENDATIONS

Always check and change the engine oil at the intervals outlined in the Periodic Maintenance Chart section. HAMMERHEAD recommends the use of 10w40 Conventional Engine Oil for this vehicle.

NOTICE

Mixing brands or using a non-recommended oil may cause serious engine damage. Always use the recommended oil. Never substitute or mix oil brands.

OIL CHECK

Maintain the oil level within the safe range on the dipstick. Do not overfill.

TIP

A rising oil level between checks in cool weather driving can indicate contaminants such as gas or moisture collecting in the crankcase. If the oil level is over the full/safe mark, change the oil immediately.

1. Position the vehicle on a level surface.
2. Remove the dipstick. Wipe it dry with a clean cloth.
3. Reinstall the dipstick completely.
4. Remove the dipstick and check the oil level.
5. Add the recommended oil as needed.
6. Reinstall the dipstick.

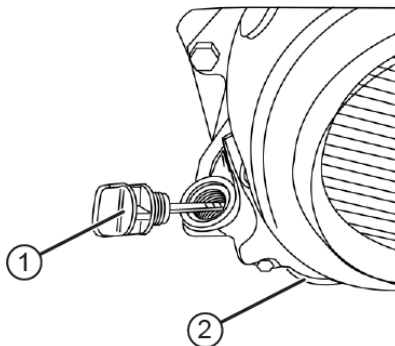

- ① Dipstick
- ② Drain Plug
- ③ Safe Range
- ④ Add Oil
- ⑤ Full

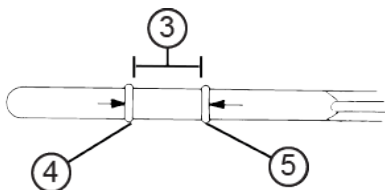

FUEL FILTER

This vehicle is equipped with an in-line fuel filter. This filter should be replaced by your dealer or other qualified person at the intervals recommended in the Periodic Maintenance Chart sections.

NOTE

Do not attempt to clean the fuel filter.

OIL CHANGE

CAUTION

Hot oil can cause burns to skin. Do not allow hot oil to contact skin.

1. Position the vehicle on a level surface. Set the parking brake.
2. Clean the area around the pre-filter plug.
3. Start the engine. Allow it to idle for two to three minutes.
4. Stop the engine.
5. Place a drain pan under the engine crankcase.
6. Remove the pre-filter plug. Allow the oil to drain completely.
7. Wash the oil pre-filter screen with solvent to remove debris. Allow the screen to air dry.
8. The external oil filter is located behind the driver's seat in front of the battery tray. The screw on the oil filter should be replaced when oil is changed. With the oil drained from the crankcase, unscrew the oil filter and replace with a new one. Ensure that the oil filter gasket is properly seated, lubricated with oil and in good condition. Do not over tighten the oil filter.
9. Clean the pre-filter plug. Install a new sealing washer on the plug. The sealing surfaces on the plug and crankcase should be clean and free of burrs, nicks or scratches.
10. Reassemble the pre-filter screen and spring to the pre-filter plug.
11. Reinstall the pre-filter drain plug. Torque to 14 ft. lbs. (19 Nm).
12. Remove the dipstick. Add 35.5 oz. (1050 ml) of the recommended oil. Do not overfill. See the Specifications section for capacities.
13. Reinstall the dipstick.
14. Start the engine. Allow it to idle for one to two minutes.
15. Stop the engine and inspect for leaks.

MAINTENANCE

16. Check the oil level. Add oil as needed to bring the level to the upper mark on the dipstick.
17. Dispose of used oil properly.

NOTICE

This vehicle comes with an external oil cooler for the engine. Make sure to use authentic replacements from an authorized dealer.

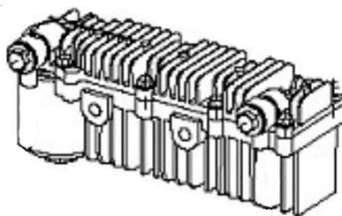

TRANSMISSION (MAIN GEARCASE)

Always check and change the fluid at the intervals outlined in the Periodic Maintenance Chart section. HAMMERHEAD recommends the use of AGL Gearcase Lubricant & Transmission Fluid for this vehicle.

FLUID CHECK

NOTE

Maximum transmission fluid volume cannot exceed 25oz. (750ml). Fill / check method is not fill to spill. Follow Fluid Change Procedure to verify transmission is filled with fluid.

The fill plug is located on the rear of the gearcase. Maintain the fluid level at the bottom of the fill plug hole.

1. Position the vehicle on a level surface.
2. Remove the fill plug①.
3. Check the fluid level.
4. Add the recommended fluid as needed.
5. Reinstall the fill plug.

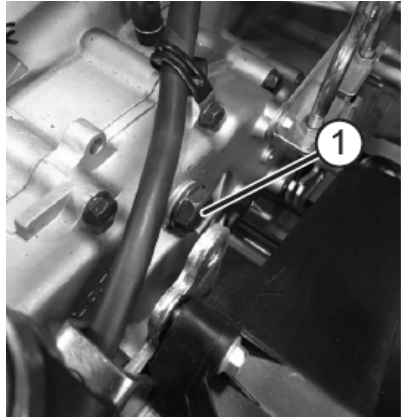

FLUID CHANGE

The drain plug is located on the right-hand side of the transmission.

1. Remove the fill plug.
2. Place a drain pan under the drain plug.
3. Remove the drain plug. Allow the fluid to drain completely.
4. Clean the drain plug.
5. Reinstall the drain plug with a new o-ring. Torque to 14 ft. lbs. (19 Nm).
6. Refill with .75 L / 25 oz of recommended gear oil. Do NOT overfill or fill to the bottom of the fill plug hole.
7. Reinstall the fill plug.

MAINTENANCE

8. Check for leaks.
9. Discard used fluid properly.

DRIVE CHAIN LUBRICATION

Lubricate the drive chain with chain spray lube or an approved chain lube at the general lubrication interval specified in the Periodic Maintenance Chart section. Lubricate more often under severe use, such as in dirty or wet conditions.

NOTICE

Washing the drive chain with a high pressure washer or gasoline can cause premature wear and drive chain failure. Don't use a high pressure washer or gasoline to clean the drive chain.

Adjusting or operating the vehicle with improper rear drive chain slack can result in severe damage to the transmission and drive components. Always make sure the slack is within the stated specifications.

DRIVE CHAIN SLACK ADJUSTMENT

1. Loosen upper nut①.
2. Turn lower nut② clockwise in 1/2 turn increments, then turn upper nut until tight. Follow this procedure until chain is at proper tension. Chain should have 1/4" to 1/2" deflection.
3. Repeat the above steps until chain is adjusted to desired fit.

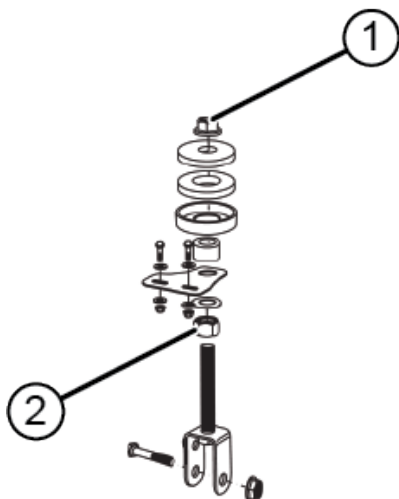

PARKING BRAKE ADJUSTMENT

1. Inspect and perform any needed service on the brake pads before adjusting the parking brake.
2. Position the vehicle on a level surface. Place the transmission in neutral.
3. Carefully elevate the rear of the vehicle slightly. Use an appropriate lift.
4. Loosen the jam nut on the parking brake adjustment bolt①.
5. While rotating the rear wheels by hand, tighten the adjustment bolt until significant brake drag is detected. Then back the adjustment bolt out 1/4 turn, or until the wheel freely spins.
6. Hold the adjustment bolt in place and tighten the jam nut securely against the lever arm.
7. Check parking brake lever movement. Verify that the rear wheels rotate freely with the parking brake off (lever in DOWN position) and that the vehicle will not move when the parking brake is applied (lever in UP position).
8. Verify that the park brake lever stays in the UP position when the brake is fully applied.

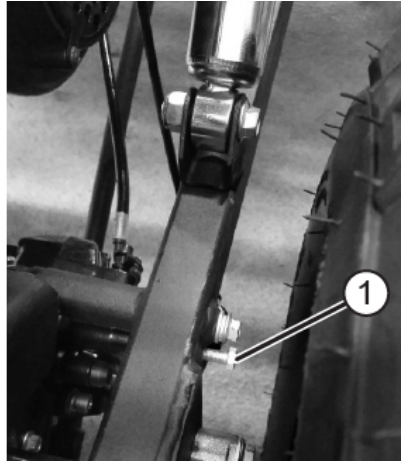

PARKING BRAKE CABLE FREEPLAY ADJUSTMENT

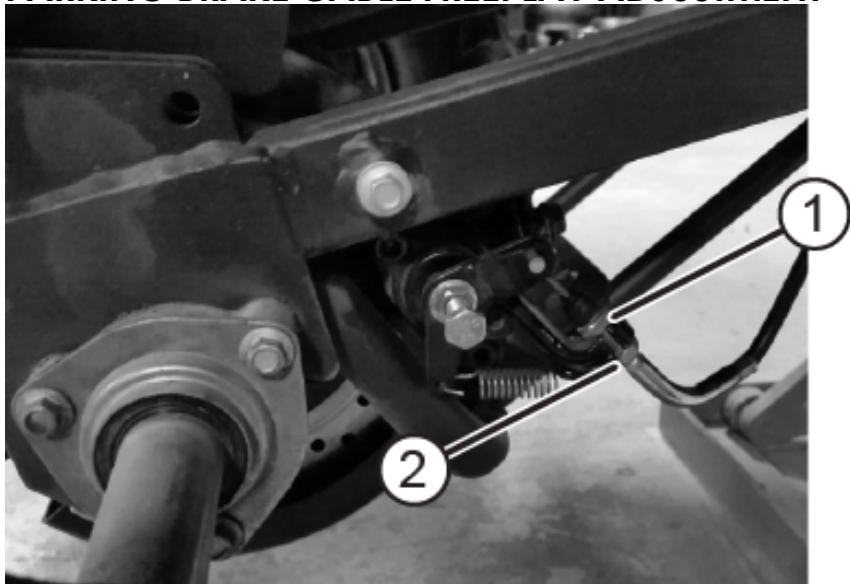

1. Inspect and perform any needed service on the brake pads before adjusting parking brake cable freeplay.
2. Make sure the parking brake is NOT set (lever is DOWN).
3. Pull the brake cable back to inspect freeplay between the cable end and the caliper bracket. Freeplay should be 1/16" - 1/8" (1.5-3 mm).
4. To adjust freeplay, loosen the jam nut①. Turn the in-line adjustment nut② outward to decrease freeplay. Turn the adjustment nut inward to increase freeplay.
5. Tighten the jam nut against the adjustment nut.

SPARK PLUG

SPARK PLUG GAP / TORQUE

CAUTION

A hot exhaust system and engine can cause burns. Wear protective gloves when removing a spark plug for inspection.

ELECTRODE GAP	NEW PLUG TORQUE	USED PLUG TORQUE
0.6 - 0.7 mm	9 - 11 ft. lbs. (12 - 15 Nm)	17 - 20 ft. lbs. (23 - 27 Nm)

NOTICE

Using non-recommended spark plugs can result in serious engine damage. Use HAMMERHEAD-recommended spark plugs or their equivalent. See the Specifications section for details.

Spark plug condition is indicative of engine operation. The spark plug firing end condition should be read after the engine is warmed up and the vehicle is driven at higher speeds. Immediately check the spark plug for correct color.

SPARK PLUG CONDITION

NORMAL SPARK PLUG

The normal insulator tip is gray, tan or light brown. There will be few combustion deposits. The electrodes are not burned or eroded. This indicates the proper type and heat range for the engine and the service.

TIP

The tip should not be white. A white insulator tip indicates overheating, caused by use of an improper spark plug or incorrect throttle body adjustments.

WET FOULED SPARK PLUG

The wet fouled insulator tip is black. A damp oil film covers the firing end. There may be a carbon layer over the entire nose. Generally, the electrodes are not worn. General causes of fouling are excessive oil, use of non-recommended oil or incorrect throttle body adjustments.

SPARK PLUG REMOVAL AND REPLACEMENT

NOTE

It is advisable to replace the spark plug at least once a year to insure easy starting and good engine performance.

1. Use a spark plug wrench to remove the spark plug.
2. Inspect the spark plug each time you change the oil. The electrodes should be kept clean and free of carbon. The presence of carbon or excess oil will reduce proper engine performance. If possible, check the spark plug gap (area between electrodes) using a wire feeler gauge.
3. Before installing spark plug, coat threads lightly with graphite grease if possible, to ensure easy removal next time the spark plug needs inspection.
4. Reverse the procedure for spark plug installation. Torque to specification.

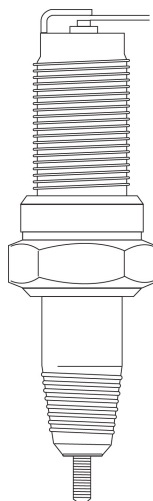

VALVE ADJUSTMENT PROCEDURE

NOTE

In order to properly set the valves, the engine must be at TDC on the compression stroke. To find TDC on the compression stroke, roll the engine over until the intake valve closes and stops at TDC.

INTAKE VALVE CLEARANCE ADJUSTMENT

1. Remove the valve cover and secondary air pipe assembly.
2. Verify cam lobes are pointed down.
3. Insert correct thickness feeler gauge between end of intake valve stem and adjuster screw.
4. When clearance is correct, hold adjuster screw and tighten locknut securely.

5. Re-check the valve clearance.
6. Repeat adjustment procedure if necessary until clearance is correct with locknut secured.

MEASUREMENT
Valve Clearance 0.004" (0.10 mm)

EXHAUST VALVE CLEARANCE ADJUSTMENT

1. Remove the valve cover and secondary air pipe assembly.
2. Verify cam lobes are pointed down.
3. Insert correct thickness feeler gauge between end of exhaust valve stem and adjuster screw.
4. Loosen locknut and turn adjuster screw until there is a slight drag on feeler gauge.
5. When clearance is correct, hold adjuster screw and tighten locknut securely.
6. Re-check the valve clearance.
7. Repeat adjustment procedure if necessary until clearance is correct with locknut secured.

MEASUREMENT
Valve Clearance 0.0047" (0.12 mm)

CONSTANT VARIABLE TRANSMISSION (CVT) SYSTEM

WARNING

Failure to comply with the instructions in this warning can result in severe injury or death.

Do not modify any component of the CVT system. Doing so may reduce its strength so that a failure may occur at a high speed. The CVT system has been precision balanced. Any modification will cause the system to be out of balance, creating vibration and additional loads on components.

The CVT system rotates at high speeds, creating large amounts of force on clutch components. Extensive engineering and testing has been conducted to ensure the safety of this product. However, as the owner, you have the following responsibilities to make sure this system remains safe:

- Always follow all recommended maintenance procedures. See your HAMMERHEAD dealer, or other qualified person, for service and repair assistance.
- This CVT system is intended for use on HAMMERHEAD products only. Do not install it in any other product.
- Always make sure the CVT housing is securely in place during operation.

CVT DRYING

There may be some instances when water is accidentally ingested into the CVT system. Use the following instructions to dry it out before operating.

NOTICE

Exposure to salt water will cause corrosion to metal components. If your vehicle is operated in salt water areas, rinse it off frequently with fresh water.

1. Shift the transmission to neutral. Set the parking brake.
2. Start the engine. Apply varying throttle for 10-15 seconds to expel the moisture and air-dry the belt and clutches. Do not hold the throttle wide open for more than 10 seconds.
3. Allow the engine RPM to settle to idle speed.
4. Test for belt slippage. If the belt slips, repeat the process.
5. Your vehicle requires service as soon as possible. A HAMMERHEAD dealer, or other qualified person, can assist.

AIR FILTER

Always change the air filter at the intervals outlined in the Periodic Maintenance Chart section.

NOTICE

Never operate the vehicle with the filter element removed. Dirt will enter the engine, causing rapid wear and severe damage to the engine.

1. The air filter box must be completely removed to access the air filter. To remove, loosen the two (2) bolts^① securing the box to the frame, as well as the attached intake clamp.
2. Pull air filter box away from the machine.
3. Loosen the five (5) screws on the outside of the air filter box and remove the air filter.
4. Remove the air cleaning element.
5. Remove and replace paper filter.
6. Apply a commercially available chassis lubricant to the inside lip of the new air filter. Install the filter and tighten the clamp.
7. Reinstall the access cover.

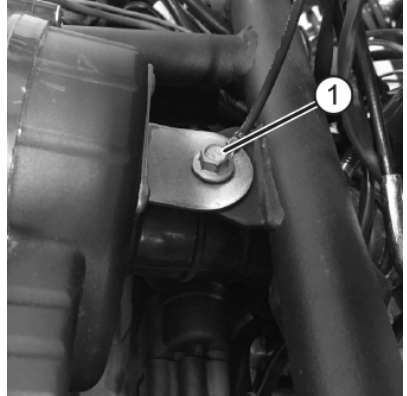

Intake Clamp



THROTTLE SYSTEM

WARNING

Failure to check or maintain proper operation of the throttle system can result in an accident and lead to serious injury or death if the throttle pedal sticks during operation.

Never start or operate this vehicle if it has a sticking or improperly operating throttle pedal. Immediately contact your HAMMERHEAD dealer or other qualified person for service if throttle problems arise. Always check the pedal for free movement and return before starting the engine and occasionally during operation.

THROTTLE FREEPLAY

If the throttle pedal has excessive play due to cable stretch or misalignment, it will cause a delay in throttle response, especially at low engine speed. The throttle may also not open fully. If the throttle pedal has no freeplay, the throttle may be hard to control, and the idle speed may be erratic.

Check the throttle pedal freeplay at the intervals outlined in the Periodic Maintenance Chart section. Adjust the freeplay if necessary.

THROTTLE FREEPLAY INSPECTION

1. Place the transmission in neutral. Set the parking brake.
2. Start the engine. Allow it to warm up thoroughly.
3. Measure the distance the throttle pedal moves before the engine begins to pick up speed.

THROTTLE FREEPLAY ADJUSTMENT

Access the throttle cable adjuster through the right front wheel well.

1. Slide the cable adjuster boot off the cable adjuster.
2. Squeeze the end of the rubber boot① and slide it far enough to expose the end of the in-line cable adjuster②.
3. Loosen the adjuster lock nut③.
4. Move the cable adjuster until desired freeplay is achieved at the throttle pedal. While adjusting, lightly flip the throttle pedal up and down.
5. Tighten the lock nut.
6. Apply a small amount of grease to the inside of the boot and slide it over the cable adjuster to its original position.

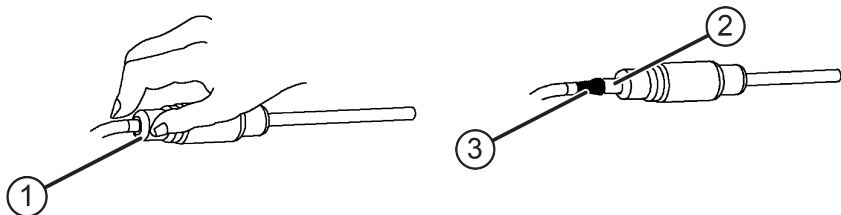

MAINTENANCE

BRAKES

The front and rear brakes are hydraulic disc type brakes activated by the brake pedal.

Always check brake pedal travel and the brake fluid reservoir level before each use of the vehicle. When applied, the brake pedal should feel firm. Any sponginess would indicate a possible fluid leak or low brake fluid level, which must be corrected before riding.

If you discover any irregularities in brake system operation, including excessive pedal travel, contact your dealer for proper diagnosis and repairs.

WARNING

Operating the vehicle with a spongy brake pedal can result in loss of braking, which could cause an accident resulting in severe injury or death. Never operate the vehicle with a spongy-feeling brake pedal.

BRAKE INSPECTION

1. Check the brake system for fluid leaks.
2. Check the brake pedal for excessive travel or a spongy feel.
3. Check the brake pads for wear, damage and looseness.
4. Inspect the brake pad wear surface for excessive wear.
5. Change pads when the friction material is worn to 0.04" (1 mm).
6. Check the surface condition of the brake discs. Measure the thickness of the rear disc. Replace a disc if the thickness is less than 1" (2.5 mm).
7. Check brake system hoses and fittings for cracks, deterioration, abrasion and leaks. Tighten any loose fittings and replace any worn or damaged parts.

① Brake Pad

② Rear Disc

③ Front Disc

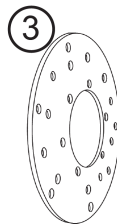
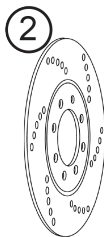
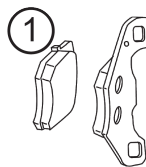

BRAKE FLUID

Inspect the level of the brake fluid before each operation. If the fluid level is low add DOT 4 brake fluid only.

⚠ WARNING

After opening a bottle of brake fluid, always discard any unused portion. Never store or use a partial bottle. Brake fluid is hygroscopic, meaning it rapidly absorbs moisture from the air. The moisture causes the boiling temperature of the brake fluid to drop, which can lead to early brake fade and the possibility of accident or severe injury.

Change the brake fluid every two years and any time the fluid becomes contaminated, the fluid level is below the minimum, or if the type and brand of the fluid in the reservoir are unknown. Access the brake fluid reservoir through the front of the vehicle, near the left headlamp.

1. Position the vehicle on a level surface.
2. Place the transmission in neutral. Set the parking brake.
3. View the brake fluid level in the reservoir. The level should be between the maximum and minimum level lines. Add brake fluid as needed.
4. Apply the brake forcefully for a few seconds and check for fluid leakage around the fittings.

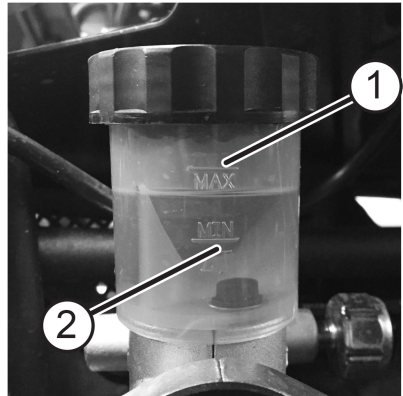

STEERING WHEEL INSPECTION

Check the steering wheel for specified freeplay and smooth operation at the intervals outlined in the Periodic Maintenance Chart section.

1. Position the vehicle on level ground.
2. Lightly turn the steering wheel left and right.
3. If there is excessive freeplay or strange noises, or the steering feels rough or “catchy,” have the steering system inspected by an authorized HAMMERHEAD dealer or other qualified service facility before operating the vehicle.

MAINTENANCE

TOE ALIGNMENT

Use the following procedure to check the toe alignment of the vehicle. The recommended toe alignment is 1/8" to 1/4" (3-6 mm) toe out.

⚠ WARNING

Severe injury or death can result from improper toe alignment and adjustment. Do not attempt to adjust tie rod alignment. All tie rod adjustments should be performed by an authorized HAMMERHEAD dealer or other qualified service facility.

1. Position the vehicle on a level surface.
2. Set the steering wheel in a straight-ahead position and secure them in this position.
3. Place a chalk mark on the center line① of the front tires as close to the hub/axle center line as possible. Make sure both marks are the same distance from the floor.
4. Measure the distance between the marks and record the measurement.
5. Move the vehicle to rotate the tires 180°. Position the wheels with the chalk marks at the rear of the tires, even with the hub/axle center line.
6. Measure the distance between the marks and record the measurement.
7. Subtract the second measurement from the first measurement. The difference is the vehicle toe-out alignment.
8. If you discover improper alignment, your HAMMERHEAD dealer or other qualified person can assist.

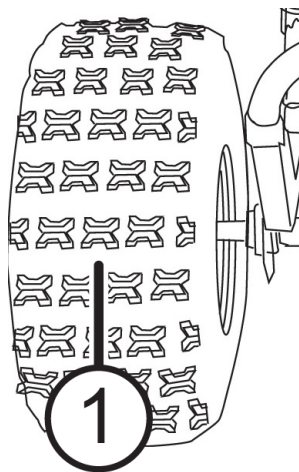

SHOCK SPRING ADJUSTMENT

WARNING

Uneven adjustment may cause poor handling of the vehicle, which could result in an accident. Always adjust both the left and right spring preloads equally. An authorized dealer can assist.

The front and rear shock absorber springs are adjustable to increase or decrease spring tension. There are five (5) adjustable positions on each shock. Use a round nut wrench to rotate the adjuster  to make adjustments. The tension of the shock spring will increase when turned left, and decrease when turned right. Adjust according to weight of the rider.

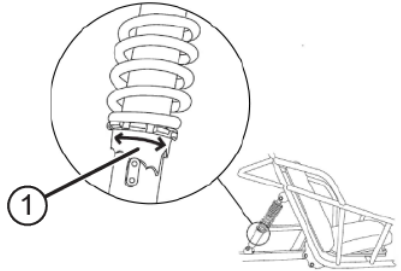

TIRES

WARNING

Operating your vehicle with worn tires will increase the possibility of skidding, loss of control and an accident, which could result in serious injury or death. Always replace tires when the tread depth measures 1/8" (3 mm) or less.

Improper tire inflation or the use of non-standard size or type of tires may adversely affect vehicle handling, which could result in vehicle damage or personal injury. Always maintain proper tire pressure. Always use HAMMERHEAD-approved size and type of tires for this vehicle when replacing tires.

TIRE TREAD DEPTH

Always replace tires when tread depth is worn to 3 mm (1/8") or less.

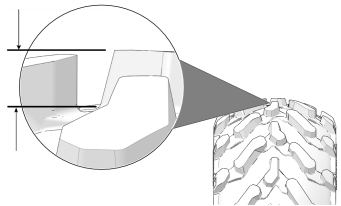

MAINTENANCE

FRONT WHEEL HUB TIGHTENING

Front wheel bearing tightness and spindle nut retention are critical component operations. All service must be performed by your authorized dealer or other qualified service facility.

WHEEL NUT TORQUE SPECIFICATIONS

Check the wheel nut torques occasionally and when they've been loosened for service.

LOCATION	NUT TORQUE
Front Wheel	70 ± 11 ft. lbs. (95 ± 15 Nm)
Rear Wheel	70 ± 11 ft. lbs. (95 ± 15 Nm)

WHEEL REPLACEMENT

NOTE

Do not disassemble the castle nuts when you replace the wheel and hub assembly.

⚠ WARNING

Improperly installed wheels can adversely affect tire wear and vehicle handling, which can result in serious injury or death. Always ensure that all nuts are torqued to specification. Do not service axle nuts that have a cotter pin installed. An authorized dealer can assist.

1. Position the vehicle on a level surface.
2. Place the transmission in neutral. Set the parking brake. Stop the engine.
3. Loosen the wheel nuts slightly.
4. Elevate the side of the vehicle by placing a suitable stand under the frame.
5. Remove the wheel nuts.
6. Remove the wheel.
7. Reverse steps to install.

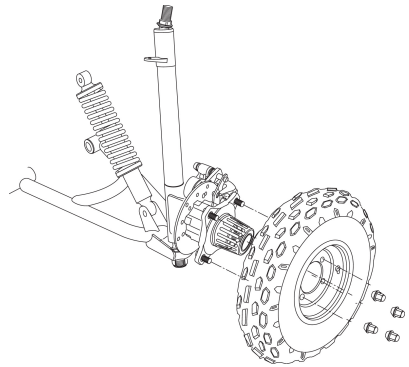

MAINTENANCE

LIGHTS

HEADLAMP REPLACEMENT

If a headlight becomes damaged or inoperable, the entire headlight assembly must be replaced. An authorized dealer can assist.

TAIL LIGHT LAMP REPLACEMENT

If the brake light doesn't work, the lamp may need to be replaced.

1. Remove the two screws securing the lens cover.
2. Remove the lens cover.
3. Remove the lamp and replace it with a new recommended lamp.
4. Test the light for proper operation.
5. Reinstall the lens cover.

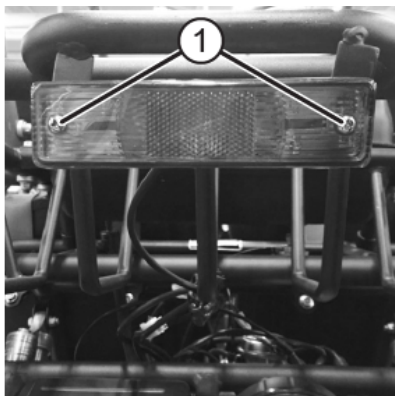

VEHICLE IMMERSION

NOTICE

If your vehicle becomes immersed, major engine damage can result if the machine is not thoroughly inspected. Take the vehicle in for service before starting the engine. Your HAMMERHEAD dealer or authorized person can assist.

If it's impossible to take your vehicle to a dealer before starting it, follow the steps outlined below

1. Move the vehicle to dry land.
2. Check the air box. If water is present, dry the air box and replace the filter with a new filter. Thoroughly dry the air pre-filter. See the Air Filter section for details.
3. Remove the air box drain plug to drain any water. Reinstall the drain plug securely.
4. Remove the spark plug.
5. Loosen carburetor drain screw.
6. Turn the engine over several times using the electric start.

7. Re-tighten the carburetor drain screw.
8. Dry the spark plug and reinstall it, or install a new plug.
9. Attempt to start the engine. If necessary, repeat the drying procedure.
10. Take the vehicle in for service as soon as possible, whether you succeed in starting it or not. Your HAMMERHEAD dealer can provide the required service.
11. If water has been ingested into the transmission follow the procedure in the CVT Drying section.

BATTERY

WARNING

Improperly connecting or disconnecting battery cables can result in an explosion and cause serious injury or death. When removing the battery, always disconnect the negative (black) cable first. When reinstalling the battery, always connect the negative (black) cable last.

WARNING

Battery electrolyte is poisonous. It contains sulfuric acid. Serious burns can result from contact with skin, eyes or clothing.

Antidote:

External: Flush with water.

Internal: Drink large quantities of water or milk. Follow with milk of magnesia, beaten egg, or vegetable oil. Call physician immediately.

Eyes: Flush with water for 15 minutes and get prompt medical attention.

Batteries produce explosive gases. Keep sparks, flame, cigarettes, etc. away. Ventilate when charging or using in an enclosed space. Always shield eyes when working near batteries. **KEEP OUT OF REACH OF CHILDREN.**

Your vehicle may have either a sealed battery, which requires little maintenance, or a conventional battery. A sealed battery can be identified by its flat covers on the top of the battery. A conventional battery has six filler caps on the top of the battery.

Always keep battery terminals and connections free of corrosion. If cleaning is necessary, remove corrosion with a stiff wire brush. Wash with a solution of one tablespoon baking soda and one cup water. Rinse well with tap water and dry off with clean shop towels. Coat the terminals with dielectric grease or petroleum jelly. Be careful not to allow cleaning solution or tap water into a conventional battery.

BATTERY REMOVAL

NOTICE

If electrolyte spills, immediately wash it off with a solution of one tablespoon baking soda and one cup water to prevent damage to the vehicle.

1. The battery can be accessed from the rear of the vehicle, behind the driver's seat. Remove strap and battery cover.
2. On conventional batteries, remove the battery vent tube (sealed batteries do not have a vent tube).
3. Disconnect the negative battery cable (green) first.
4. Disconnect the positive (red) battery cable last.
5. Lift the battery out of the vehicle. Be careful not to tip a conventional battery sideways, which could spill electrolyte.

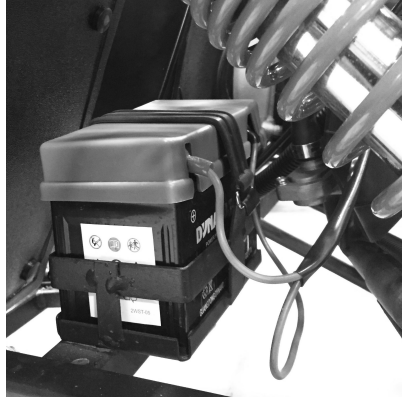

BATTERY INSTALLATION

Using a new battery that has not been fully charged can damage the battery and result in a shorter life. It can also hinder vehicle performance. Follow the instructions detailed in the Battery Charging section before installing the battery.

1. Ensure that the battery is fully charged.
2. Place the battery in the battery holder.
3. Coat the terminals with dielectric grease or petroleum jelly.
4. Connect and tighten the red (positive) cable first.
5. Connect and tighten the black (negative) cable last.
6. Verify that cables are properly routed.
7. Put battery cover back on, and reattach strap.

MAINTENANCE

BATTERY STORAGE

Whenever the vehicle is not used for a period of three months or more, remove the battery from the vehicle, ensure that it's fully charged, and store it out of the sun in a cool, dry place. Check battery voltage each month during storage and recharge as needed to maintain a full charge.

TIP

Battery charge can be maintained by using a Battery Tender charger or by charging about once a month to make up for normal self-discharge. Battery Tender can be left connected during the storage period, and will automatically charge the battery if the voltage drops below a pre-determined point.

BATTERY CHARGING

The following battery charging instructions apply only to the installation of a sealed battery. Read all instructions before proceeding with the installation of this battery.

The sealed battery is already filled with electrolyte and has been sealed and *fully charged* at the factory. *Never* pry the sealing strip off or add any other fluid to this battery.

The single most important thing about maintaining a sealed battery is to keep it fully charged. Since the battery is sealed and the sealing strip cannot be removed, you must use a voltmeter or multimeter to measure DC voltage.

WARNING

An overheated battery may explode, causing severe injury or death. Always watch charging times carefully. Stop charging if the battery becomes very warm to the touch. Allow it to cool before resuming charging.

For a refresh charge, follow all instructions carefully.

1. Check the battery voltage with a voltmeter or multimeter. A fully charged battery will register 12.8 V or higher.
2. If the voltage is less than 12.8 volts, recharge the battery at 1.2 amps or less until battery voltage is 12.8 or greater.

TIP

When using an automatic charger, refer to the charger manufacturer's instructions for recharging. When using a constant current charger, use the guidelines below for recharging.

Always verify battery condition before and 1-2 hours after the end of charging.

MAINTENANCE

STATE OF CHARGE	VOLTAGE	ACTION	CHARGE TIME*
*(USING CONSTANT CURRENT CHARGER @ STANDARD AMPS SPECIFIED ON TOP OF BATTERY)			
100%	12.8-13.0 volts	None, check at 3 mos. from date of manufacture	None required
75%-100%	12.5-12.8 volts	May need slight charge, if no charge given, check in 3 months	3-6 hours
50%-75%	12.0-12.5 volts	Needs charge	5-11 hours
25%-50%	11.5-12.0 volts	Needs charge	At least 13 hours, verify state of charge
0%-25%	11.5 volts or less	Needs charge with desulfating charger	At least 20 hours

CLEANING AND STORAGE

WASHING THE VEHICLE

Keeping your HAMMERHEAD vehicle clean will not only improve its appearance but it can also extend the life of various components.

Before washing the vehicle, locate the CVT inlet and outlet ducts. Avoid spraying water directly toward the ducts.

NOTICE

Water in the CVT system could cause the drive belt to become wet and slip in the clutches. Always avoid spraying water directly toward the CVT inlet and outlet ducts.

High water pressure may damage components. HAMMERHEAD recommends washing the vehicle by hand or with a garden hose, using mild soap.

Certain products, including insect repellents and chemicals, will damage plastic surfaces. Do not allow these types of products to contact the vehicle.

The best and safest way to clean your HAMMERHEAD vehicle is with a garden hose and a pail of mild soap and water.

1. Use a professional-type washing cloth, cleaning the upper body first and the lower parts last.
2. Rinse with clean water frequently.
3. Dry surfaces with a chamois to prevent water spots.

Washing Tips

- Avoid the use of harsh cleaners, which can scratch the finish.
- Do not use a power washer to clean the vehicle.
- Do not use medium to heavy duty compounds on the finish.
- Always use clean cloths and pads for cleaning and polishing. Old or reused cloths and pads may contain dirt particles that will scratch the finish.

If a high pressure water system is used for cleaning (not recommended), exercise extreme caution. The water may damage components and could remove paint and labels. Avoid directing the water stream at the following items:

- Wheel bearings
- Radiator
- Transmission seals
- CVT inlet and outlet ducts
- Brakes
- Cab and body panels

- Labels and decals
- Electrical components and wiring

If an informational or graphic label becomes illegible or comes off, contact your HAMMERHEAD dealer to purchase a replacement. Replacement safety labels are provided by HAMMERHEAD at no charge.

Grease all zerk fittings immediately after washing. Allow the engine to run for a while to evaporate any water that may have entered the engine or exhaust system.

POLISHING THE VEHICLE

HAMMERHEAD recommends the use of common household aerosol furniture polish for polishing the finish on your HAMMERHEAD vehicle. Follow the instructions on the container.

Polishing Tips

- Avoid the use of automotive products, some of which can scratch the finish of your vehicle.
- Always use clean cloths and pads for cleaning and polishing. Old or reused cloths and pads may contain dirt particles that will scratch the finish.

CHROME WHEEL CARE (IF EQUIPPED)

Proper maintenance will protect chrome wheels from corrosion, preserve wheel life and ensure a "like new" appearance for many years. Chrome wheels exposed to road salt (or salt in the air in coastal areas) are more susceptible to corrosion if not properly cleaned. Clean chrome wheels more often if they're exposed to salt or other corrosive elements.

1. Wash chrome wheels frequently. Use a mild detergent. Never use abrasive cleaners on plated or painted surfaces.
2. Rinse well with clear water. Soap, detergents, salt, dirt, mud, and other elements can cause corrosion.
3. Polish the clean chrome wheels periodically. Use an automotive grade chrome polish.
4. Routinely and liberally apply a weather resistant wax to each polished chrome wheel. Choose a product suitable for chrome finishes. Read and follow the product labels and instructions.

REMOVING CORROSION

If light rust is found on the chrome finish, use steel wool (#0000-OTT grade) to remove it. Gently rub the affected areas with the steel wool until the corrosion has been removed. Clean and polish the wheel as outlined above.

MAINTENANCE

STORAGE TIPS

NOTICE

Starting the engine during the storage period will disturb the protective film created by fogging and damage could occur. Never start the engine during the storage period.

CLEAN THE EXTERIOR

Make any necessary repairs and clean the vehicle as recommended. See the Washing the Vehicle section for details..

STABILIZE THE FUEL

1. Fill the fuel tank.
2. Add Carbon Clean Fuel Treatment or equivalent fuel treatments or stabilizers. Follow the instructions on the container for the recommended amount. Carbon Clean removes water from fuel systems, stabilizes fuel and removes carbon deposits from pistons, rings, valves and exhaust systems.
3. Allow the engine to run for 15-20 minutes in a well ventilated area to allow the stabilizer to disperse through the entire fuel delivery system.

AIR FILTER / AIR BOX

Inspect and clean or replace the air filter. See the Air Filter section for details. Clean the air box. Drain the sediment tube.

FLUID LEVELS

Inspect the fluid levels. Add or change fluids as recommended in the Periodic Maintenance Chart section.

- Transmission fluid
- Brake fluid (change every two years and any time the fluid looks dark or contaminated)

ENGINE OIL

Change the oil. See the Engine Oil section for details.

INSPECT AND LUBRICATE

Inspect all cables and lubricate all areas of the vehicle as recommended in the Periodic Maintenance Chart section.

FOG THE ENGINE

1. Treat the fuel system with Carbon Clean or other equivalent fuel treatment. Follow the instructions on the container. Start the engine. Allow it to idle for several minutes so the Carbon Clean reaches the injectors. Stop the engine.
2. Remove the spark plug and add 2-3 tablespoons of engine oil. To access the plug hole, use a section of clear 1/4" hose and a small plastic squeeze bottle filled with the pre-measured amount of oil.
3. Reinstall the spark plug. Torque to specification. See the Spark Plug section for details.
4. Apply dielectric grease to the inside of each spark plug cap. *Do not reinstall the cap onto the plug at this step.*
5. Turn the engine over several times. Oil will be forced in and around the piston rings and ring lands, coating the cylinder with a protective film of fresh oil.
6. If fuel system additive is not used, fuel tank, fuel lines, and injectors should be completely drained of gasoline.
7. Reinstall the spark plug cap to the spark plug.

BATTERY MAINTENANCE

Remove the battery and recharge it as outlined in the Battery Charging section. Store the battery in a cool, dry place.

STORAGE AREA / COVERS

Be sure the storage area is well ventilated. Do not use plastic or coated materials. They do not allow enough ventilation to prevent condensation, and may promote corrosion and oxidation.

REMOVAL FROM STORAGE

1. Check the battery electrolyte level and charge the battery if necessary. Install it in the vehicle. Make sure the battery vent hose is routed properly and that it's not pinched or restricted in any way.
2. Make sure the spark plug is tight.
3. Fill the fuel tank with fuel.
4. Check all the points listed in the Daily Pre-Ride Inspection section. Tightness of the bolts, nuts and other fasteners should be checked by an authorized HAMMERHEAD dealer or other qualified service facility.
5. Lubricate at the intervals outlined in the Periodic Maintenance Chart section.

TRANSPORTING THE VEHICLE

Follow these procedures when transporting the vehicle.

NOTICE

Always tie the frame of the HAMMERHEAD vehicle to the transporting unit securely with suitable straps or rope. Do not attach tie straps to the front control arm bolt pockets.

1. Place the transmission in neutral. Set the parking brake.
2. Stop the engine.
3. Remove the key to prevent loss during transporting.
4. Secure the fuel cap and seats. Ensure that the seats are attached correctly and are not loose.
5. Wrap the front tie strap through the frame tubes, or attach a tie-down hook around each of the tubes.
6. Wrap the rear tie strap around the swing arm.

SPECIFICATIONS

GTS 150

Engine	Engine/Motor Type	4-Stroke
	Displacement	149cc
	Cooling	Air
	Starting	Electric
	Fuel System	Carburetor
	Fuel Capacity	1.75 Gal
	Fuel Type	Unleaded. Never use fuel with higher than 10% ethanol.
	Engine Oil Capacity	35.5 oz. (1050 ml)
	Engine Oil Type	SAE-10W/40
	Spark Plug Type	CR7HSA (NGK)
Drivetrain	Drive/Clutch	Automatic CVT
	Drive Type	2-Wheel Drive
	Transmission/Transaxle	F/N/R
	Driveline	Chain
Chassis	Front Suspension	Dual A-Arm
	Rear Suspension	Swing Arm
	Steering	Rack & Pinion
	Front Brake	Hydraulic Disc (2)
	Rear Brake	Hydraulic Disc
	Seats	Individual Race Style
	Seat belt	5-Point Harness
Tires	Body	Brush Guard
	Front Tires	19x7-8
	Rear Tires	22x10-10
	Wheels	Steel
	Operating Tire Pressure Front	10 PSI

SPECIFICATIONS

	Operating Tire Pressure Rear	10 PSI
Dimensions	Length	87"
	Width	55"
	Height	55"
	Wheelbase	59"
	Ground Clearance	5.8"
	Bed/Rack Dimensions L x W x H	32" x 10" x 9"
	Distance Seat to Pedal (Front Edge)	21" - 24"
	Distance Seat to Pedal (Seat Back)	38" - 41"
Capacity	Bed/Rack Capacity	50 lbs
	Towing Capacity	N/A
	Vehicle Capacity	400 lbs
	Fuse	15A
	Battery	12V / 9 Amp Hours
Weight	Dry Weight	515 lbs

ENGINE TUNE-UP SPECIFICATION

Idle Mixture	Non-Adjustable
Intake Valve Clearance	0.004" (0.1 mm)
Exhaust Valve Clearance	0.0047" (0.12 mm)
Spark Plug	CR7HSA (NGK)
Spark Plug Gap	0.6 - 0.7 mm
Ignition Timing	Non-Adjustable
Idle Speed	1700 +/- 100 RPM in Neutral
Fuel	Unleaded Gasoline Only 87 (R+M)/2 Octane or Higher
Oil	10W 40

GTS 150 LE

Engine	Engine/Motor Type	4-Stroke
	Displacement	149cc
	Cooling	Air
	Starting	Electric
	Fuel System	Carburetor
	Fuel Capacity	1.75 Gal
	Fuel Type	Unleaded. Never use fuel with higher than 10% ethanol.
	Engine Oil Capacity	35.5 oz. (1050 ml)
	Engine Oil Type	SAE-10W/40
	Spark Plug Type	CR7HSA (NGK)
Drivetrain	Drive/Clutch	Automatic CVT
	Drive Type	2-Wheel Drive
	Transmission/Transaxle	F/N/R
	Driveline	Chain
Chassis	Front Suspension	Dual A-Arm
	Rear Suspension	Swing Arm
	Steering	Rack & Pinion
	Front Brake	Hydraulic Disc (2)
	Rear Brake	Hydraulic Disc
	Seats	Individual Race Style
	Seat belt	5-Point Harness
	Body	Brush Guard
Tires	Front Tires	19x7-8
	Rear Tires	22x10-10
	Wheels	Aluminum
	Operating Tire Pressure Front	10 PSI
	Operating Tire Pressure Rear	10 PSI

SPECIFICATIONS

Dimensions	Length	87"
	Width	55"
	Height	55"
	Wheelbase	59"
	Ground Clearance	5.8"
	Bed/Rack Dimensions L x W x H	14" x 23" x 4"
	Distance Seat to Pedal (Front Edge)	21" - 24"
	Distance Seat to Pedal (Seat Back)	38" - 41"
Capacity	Bed/Rack Capacity	50 lbs
	Towing Capacity	N/A
	Vehicle Capacity	400 lbs
	Fuse	15A
	Battery	12V / 9 Amp Hours
Weight	Dry Weight	515 lbs

ENGINE TUNE-UP SPECIFICATION

Idle Mixture	Non-Adjustable
Intake Valve Clearance	0.004" (0.1 mm)
Exhaust Valve Clearance	0.0047" (0.12 mm)
Spark Plug	CR7HSA (NGK)
Spark Plug Gap	0.6 - 0.7 mm
Ignition Timing	Non-Adjustable
Idle Speed	1700 +/- 100 RPM in Neutral
Fuel	Unleaded Gasoline Only 87 (R+M)/2 Octane or Higher
Oil	10W 40

CARBURETOR JETTING CHART

CARBURETOR JETTING CHART									
Carburetor Jetting Chart for Altitude and Ambient Temperature Changes									
ALTITUDE Feet (Meters)	AMBIENT TEMPERATURE								
	°F:	Below -25	-30 to -10	-15 to +5	0 to +20	+15 to +35	+30 to +50	+45 to +65	Above +60
	°C:	Below -31	-34 to -23	-26 to -15	-18 to -7	-9 to +2	-1 to +10	+7 to +18	Above +16
0-2000 (0-600)	Main Jet	112	112	112	112	111	111	111	111
	Pilot Jet	38	38	38	38	35	35	35	35
	Needle	2 shims	2 shims	2 shims	2 shims	1 shim	1 shim	1 shim	1 shim
2000-4000 (600-1200)	Main Jet	112	112	112	112	111	111	111	111
	Pilot Jet	38	38	38	38	35	35	35	35
	Needle	2 shims	2 shims	2 shims	2 shims	1 shim	1 shim	1 shim	1 shim
4000-6000 (1200-1800)	Main Jet	111	111	111	111	110	110	110	110
	Pilot Jet	35	35	35	35	35	35	35	35
	Needle	1 shim	1 shim	1 shim	1 shim	1 shim	1 shim	1 shim	1 shim
6000-8000 (1800-2400)	Main Jet	111	111	111	111	110	110	110	110
	Pilot Jet	35	35	35	35	32	32	32	32
	Needle	1 shim	1 shim	1 shim	1 shim	No shim	No shim	No shim	No shim
8000-10000 (2400-3000)	Main Jet	110	110	110	110	109	109	109	109
	Pilot Jet	35	35	35	35	32	32	32	32
	Needle	1 shim	1 shim	1 shim	1 shim	No shim	No shim	No shim	No shim
Above 10000 (Above 3000)	Main Jet	110	110	110	110	109	109	109	109
	Pilot Jet	35	35	35	35	32	32	32	32
	Needle	1 shim	1 shim	1 shim	1 shim	No shim	No shim	No shim	No shim

TROUBLESHOOTING

DRIVE BELT WEAR / BURN

POSSIBLE CAUSE	SOLUTION
Driving at low RPM or ground speed	Drive at a higher speed.
Insufficient warm-up at low ambient temperatures	Warm the engine at least 5 minutes. With the transmission in neutral, apply small amount of throttle in short bursts, 5 to 7 times. The belt will become more flexible and prevent belt burning.
Slow/easy clutch engagement	Use the throttle quickly and effectively.
Belt slippage from water or snow ingestion into the CVT system	Dry out the CVT (see the CVT Drying section for details). <i>Prevent water from entering the CVT inlet and outlet ducts (see the Washing the Vehicle section for details).</i> Inspect clutch seals for damage if repeated leaking occurs.
Clutch malfunction	A HAMMERHEAD dealer or other authorized person can assist.
Poor engine performance	Check for fouled plug or foreign material in gas tank, fuel filter, and fuel lines. A HAMMERHEAD dealer or other authorized person can assist.
Wrong or missing belt	Install the recommended belt.
Improper break-in	Always break in a new belt and/or clutch. See the CVT Break-in (Clutches / Belt) section for details.

ENGINE DOESN'T TURN OVER

POSSIBLE CAUSE	SOLUTION
Low battery voltage	Recharge the battery to 12.8 VDC
Loose battery connections	Check all connections and tighten
Loose solenoid connections	Check all connections and tighten

ENGINE PINGS OR KNOCKS

POSSIBLE CAUSE	SOLUTION
Poor quality or low octane fuel	Replace with recommended fuel
Incorrect ignition timing	Your authorized dealer can assist
Incorrect spark plug gap or heat range	Set gap to specs or replace plugs

TROUBLESHOOTING

ENGINE TURNS OVER, FAILS TO START

POSSIBLE CAUSE	SOLUTION
Out of fuel	Refuel
Water is present in fuel	Drain the fuel system and refuel
Old or non-recommended fuel	Replace with fresh recommended fuel
Fouled or defective spark plug	Inspect plug and replace if necessary
No spark to spark plug	Inspect plug and replace if necessary
Water or fuel in crankcase	Your authorized dealer can assist
Low battery voltage	Recharge the battery to 12.8 VDC
Mechanical failure	Your authorized dealer can assist

ENGINE BACKFIRES

POSSIBLE CAUSE	SOLUTION
Weak spark from spark plug	Inspect, clean and/or replace spark plug
Incorrect spark plug gap or heat range	Set gap to specs or replace plug
Old or non-recommended fuel	Replace with fresh recommended fuel
Incorrectly installed spark plug wires	An authorized dealer can assist
Incorrect ignition timing	An authorized dealer can assist
Mechanical failure	An authorized dealer can assist
Loose ignition connections	Check all connections and tighten
Water present in fuel	Replace with fresh recommended fuel
Exhaust system leak	An authorized dealer can assist

ENGINE RUNS IRREGULARLY, STALLS OR MISFIRES

POSSIBLE CAUSE	SOLUTION
Fouled or defective spark plug	Inspect, clean and/or replace spark plugs
Worn or defective spark plug wires	An authorized dealer can assist
Incorrect spark plug gap or heat range	Set gap to specs or replace plugs
Loose ignition connections	Check all connections and tighten
Water present in fuel	Replace with new fuel
Low battery voltage	Recharge battery to 12.8 VDC
Clogged fuel cap vent	Inspect and replace
Incorrect fuel	Replace with recommended fuel
Clogged air filter	Inspect and clean or replace
Throttle control malfunction	An authorized dealer can assist
Other mechanical failure	An authorized dealer can assist

POSSIBLE LEAN FUEL CAUSE	SOLUTION
Low or contaminated fuel	Add or change fuel, clean the fuel system
Low octane fuel	Replace with recommended fuel
Clogged fuel filter	An authorized dealer can assist
Incorrect fuel	Replace with recommended fuel

POSSIBLE RICH FUEL CAUSE	SOLUTION
Fuel is very high octane	Replace with lower octane fuel
Stopping/starting without adequate warm-up	Allow engine to warm up before operating and/or stopping
Incorrect fuel	Replace with recommended fuel
Clogged air filter	Inspect and clean or replace

TROUBLESHOOTING

ENGINE STOPS OR LOSES POWER

POSSIBLE CAUSE	SOLUTION
Out of fuel	Refuel
Clogged fuel cap vent	Inspect and replace
Water is present in fuel	Replace with new fuel
Fouled or defective spark plug	Inspect, clean and/or replace spark plug
Worn or defective spark plug wires	An authorized dealer can assist
Incorrect spark plug gap or heat range	Set gap to specs or replace plug
Loose ignition connections	Check all connections and tighten
Low battery voltage	Recharge the battery to 12.8 VDC
Incorrect fuel	Replace with fresh recommended fuel
Clogged air filter	Inspect and clean or replace
Throttle control malfunction	An authorized dealer can assist
Other mechanical failure	An authorized dealer can assist

WARRANTY

LIMITED WARRANTY

HAMMERHEAD Inc., 1200 Lakeside Parkway Ste. 400 Flower Mound, TX 75028 (HAMMERHEAD) provides a ONE HUNDRED and EIGHTY DAY PARTS ONLY LIMITED WARRANTY against defects in material or workmanship for all vehicle frames and engines. This PARTS ONLY LIMITED WARRANTY covers parts charges for repair or replacement of defective parts but does not cover any related labor charges or expense.

HAMMERHEAD provides a NINETY DAY PARTS AND LABOR LIMITED WARRANTY against defects in material or workmanship for all other components, except those consumable, general wear, and exposed to friction components referenced in the following paragraph. This NINETY DAY LIMITED WARRANTY covers parts and labor charges for repair or replacement of defective parts.

HAMMERHEAD provides a THIRTY DAY LIMITED WARRANTY against defects in material or workmanship on all consumable components, general wear items, or any parts exposed to friction surfaces, stresses, environmental conditions and/or contamination for which they were not designed or not intended; including but not limited to the following items:

- Wheels and Tires
- Suspension Components
- Brake Components
- Seat Components
- Clutches and Components
- Steering Components
- Batteries
- Light Bulbs / Sealed Beam Lamps
- Filters
- Lubricants
- Bushings
- Cables
- Finished and Unfinished Surfaces
- Carburetor/Throttle Body Components
- Engine Components
- Drive Belts
- Hydraulic Components and Fluids
- Circuit Breakers/Fuses
- Electronic Components
- Spark Plugs
- Sealants
- Coolants
- Bearings
- Vehicle Tops

This THIRTY DAY LIMITED WARRANTY covers parts and labor charges for repair or replacement of defective parts.

The duration of these warranties may vary by international region based upon local laws and regulations. These warranties begin on the date of purchase by the original retail purchaser.

WARRANTY

REGISTRATION IMPORTANT!

ALL UNITS MUST BE REGISTERED WITHIN 14 DAYS OF PURCHASE.

To register your product a copy of the Warranty Registration Form and sales receipt must be forwarded to HAMMERHEAD Off-Road. Your dealer, with your assistance, will complete and forward these items to HAMMERHEAD Off-Road. A copy of the Warranty Registration Card and Buyer Safety Agreement is attached. It is your responsibility to confirm with your dealer within 14 days of purchase that your product has been registered. If you are unable to confirm with your dealer within 14 days of purchase that your product has been registered, please contact HAMMERHEAD Off-Road within 14 days of purchase.

WARRANTY COVERAGE AND EXCLUSIONS: LIMITATIONS OF WARRANTIES AND REMEDIES

This HAMMERHEAD limited warranty excludes any failures that are not caused by a defect in material or workmanship. **THIS WARRANTY DOES NOT COVER CLAIMS OF DEFECTIVE DESIGN.** This warranty also does not cover acts of God, accidental damage, normal wear and tear, abuse or improper handling. This warranty also does not cover any vehicle, component, or part that has been altered structurally, modified, neglected, improperly maintained or used for racing, competition or purposes other than for which it was designed.

This warranty excludes damages or failures resulting from: improper lubrication; improper engine timing; improper fuel; surface imperfections caused by external stress, heat, cold or contamination; operator error or abuse; improper component alignment, tension, adjustment or altitude compensation; snow, water, dirt or other foreign substance ingestion/contamination; improper maintenance; modified components; use of aftermarket or unapproved components, accessories, or attachments; unauthorized repairs; or repairs made after the warranty period expires or by an unauthorized repair center.

This warranty excludes damages or failures caused by abuse, accident, fire, or any other cause other than a defect in materials or workmanship and provides no coverage beyond the 180, 90, or 30-day period set forth above

LUBRICANTS AND FLUIDS

1. Mixing oil brands or using non-recommended oil may cause engine damage.
2. Damage or failure resulting from the use of non-recommended lubricants or fluids is not covered by this warranty.

This warranty provides no coverage for personal loss or expense, including mileage, transportation costs, hotels, meals, shipping or handling fees, product pick-up or delivery, replacement rentals, loss of product use, loss of profits, or loss of vacation or personal time.

THE EXCLUSIVE REMEDY FOR BREACH OF THIS WARRANTY SHALL BE, AT HAMMERHEAD'S OPTION, REPAIR OR REPLACEMENT OF ANY DEFECTIVE MATERIALS, COMPONENTS, OR PRODUCTS. THE REMEDIES SET FORTH IN THIS WARRANTY ARE THE ONLY REMEDIES AVAILABLE TO ANY PERSON FOR BREACH OF THIS WARRANTY. HAMMERHEAD SHALL HAVE NO LIABILITY TO ANY PERSON FOR INCIDENTAL, CONSEQUENTIAL OR SPECIAL DAMAGES OF ANY DESCRIPTION, WHETHER ARISING OUT OF EXPRESS OR IMPLIED WARRANTY OR ANY OTHER CONTRACT, NEGLIGENCE, OR OTHER TORT OR OTHERWISE. THIS EXCLUSION OF CONSEQUENTIAL, INCIDENTAL, AND SPECIAL DAMAGES IS INDEPENDENT FROM AND SHALL SURVIVE ANY FINDING THAT THE EXCLUSIVE REMEDY FAILED OF ITS ESSENTIAL PURPOSE.

THE IMPLIED WARRANTY OF FITNESS FOR A PARTICULAR PURPOSE IS EXCLUDED FROM THIS LIMITED WARRANTY. ALL OTHER IMPLIED WARRANTIES (INCLUDING BUT NOT LIMITED TO THE IMPLIED WARRANTY OF MERCHANTABILITY) ARE LIMITED IN DURATION TO THE ABOVE WARRANTY PERIODS. HAMMERHEAD DISCLAIMS ALL EXPRESS WARRANTIES NOT STATED IN THIS WARRANTY. SOME STATES DO NOT PERMIT THE EXCLUSION OR LIMITATION OF INCIDENTAL OR CONSEQUENTIAL DAMAGES OR ALLOW LIMITATIONS ON THE DURATION OF IMPLIED WARRANTIES, SO THE ABOVE LIMITATIONS MAY NOT APPLY TO YOU IF INCONSISTENT WITH CONTROLLING STATE LAW.

WARRANTY

HOW TO OBTAIN WARRANTY SERVICE

If your vehicle requires warranty service, you must take it to a HAMMERHEAD Servicing Dealer. When requesting warranty service you must present your copy of the Warranty Registration Form to the dealer. (THE COST OF TRANSPORTATION TO AND FROM THE DEALER IS YOUR RESPONSIBILITY.) HAMMERHEAD suggests that you use your original selling dealer; however, you may use any HAMMERHEAD Servicing Dealer to perform warranty service.

In the Country where your product was purchased:

Warranty or Service Bulletin repairs must be done by an authorized HAMMERHEAD dealer. If you move or are traveling within the country where your product was purchased, Warranty and Service Bulletin repairs may be requested from any authorized HAMMERHEAD dealer that sells the same line as your product.

Outside the Country where your product was purchased:

If you are traveling temporarily outside the country where your product was purchased, you should take your product to an authorized HAMMERHEAD dealer. You must show the dealer photo identification from the country of the selling dealer's authorized location as proof of residence. Upon residence verification, the servicing dealer will be authorized to perform the warranty repair.

If you move:

If you move to another country, be sure to contact HAMMERHEAD Customer Assistance and the customs department of the destination country before you move. Product importation rules vary considerably from country to country. You may be required to present documentation of your move to HAMMERHEAD in order to continue your warranty coverage. You may also be required to obtain documentation from HAMMERHEAD in order to register your product in your new country. You should warranty register your product at a local HAMMERHEAD dealer in your new country immediately after you move to continue your warranty coverage and to ensure that you receive information and notices regarding your vehicle.

If you purchase from a private party:

If you purchase a HAMMERHEAD product from a private party, to be kept and used outside of the country in which the product was originally purchased, all warranty coverage will be denied. You must nonetheless register your product under your name and address with a local HAMMERHEAD dealer in your country to ensure that you receive safety information and notices regarding your product.

EXPORTED PRODUCTS

EXCEPT WHERE SPECIFICALLY REQUIRED BY LAW, THERE IS NO WARRANTY OR SERVICE BULLETIN COVERAGE ON THIS PRODUCT IF IT IS SOLD OUTSIDE THE COUNTRY OF THE SELLING DEALER'S AUTHORIZED LOCATION. This policy does not apply to products that have received authorization for export from HAMMERHEAD. Dealers may not give authorization for export. You should consult an authorized dealer to determine this product's warranty or service coverage if you have any questions. This policy does not apply to products registered to government officials or military personnel on assignment outside the country of the selling dealer's authorized location. This policy does not apply to Safety Bulletins.

NOTICE

If your product is registered outside of the country where it was purchased and you have not followed the procedure set above, your product will no longer be eligible for warranty or service bulletin coverage of any kind, other than safety bulletins. Products registered to government officials or military personnel on assignment outside of the country where the product was purchased will continue to be covered by the Limited Warranty.

Please work with your dealer to resolve any warranty issues. Should your dealer require any additional assistance, they will contact the appropriate person at HAMMERHEAD.

This warranty gives you specific legal rights, and you may also have other rights which vary from state to state or in different countries. If any of the above terms are void because of federal, state, local law, all other warranty terms will remain in effect.

For questions call HAMMERHEAD Customer Assistance:

United States & Canada: 214-513-1700

WARRANTY

U.S.A. EPA EMISSIONS LIMITED WARRANTY

This emissions limited warranty is in addition to the HAMMERHEAD standard limited warranty for your vehicle. HAMMERHEAD Inc. warrants that at the time it is first purchased, this emissions-certified vehicle is designed, built and equipped so it conforms with applicable U.S. Environmental Protection Agency emission regulations. HAMMERHEAD warrants that the vehicle is free from defects in materials and workmanship that would cause it to fail to meet these regulations.

The warranty period for off road vehicles 100cc or greater emissions-certified vehicles starts on the date of purchase by original retail purchaser and continues for a period of 500 hours of engine operation, 5000 kilometers (3100 miles) of vehicle travel, or 30 calendar months from the date of purchase, whichever comes first. The warranty period for ATVs less than 100cc emissions-certified vehicles starts on the date of purchase by original retail purchaser and continues for a period of 250 hours of engine operation, 2500 kilometers (1550 miles) of vehicle travel, or 30 calendar months from the date of purchase, whichever comes first. This EPA emissions warranty period is extended for at least as long as the standard factory warranty that HAMMERHEAD provides on the vehicle as a whole. The EPA emissions warranty period does not further extend if you purchase additional warranty coverage in the form of a service contract or other paid warranty extension, but emission-related parts may be covered subject to the terms of any such paid service contract or paid warranty extension.

This emissions limited warranty covers components whose failure increases the vehicle's regulated emissions, and it covers components of systems whose only purpose is to control emissions. Repairing or replacing other components not covered by this warranty is the responsibility of the vehicle owner. This emissions limited warranty does not cover components whose failure does not increase the vehicle's regulated emissions.

For exhaust emissions, emission-related components include any engine parts related to the following systems:

- Air-induction system
- Fuel System
- Ignition system
- Exhaust gas recirculation systems

The following parts are also considered emission-related components for exhaust emissions:

- Aftertreatment devices
- Crankcase ventilation valves
- Sensors
- Electronic control units

The following parts are considered emission-related components for evaporative emissions:

- Fuel Tank
- Fuel Cap
- Fuel Line
- Fuel Line Fittings
- Clamps*
- Pressure Relief Valves*
- Control Valves*
- Control Solenoids*
- Electronic Controls*
- Vacuum Control Diaphragms*
- Control Cables*
- Control Linkages*
- Purge Valves
- Vapor Hoses
- Liquid / Vapor Separator
- Carbon Canister
- Canister Mounting Brackets
- Carburetor Purge Port Connector

*As related to the evaporative emission control system.

Emission-related components also include any other part whose only purpose is to reduce emissions or whose failure will increase emissions without significantly degrading engine/equipment performance. The exclusive remedy for breach of this limited warranty shall be, at the exclusive option of HAMMERHEAD, repair or replacement of any defective materials, components or products. THE REMEDIES SET FORTH IN THIS LIMITED WARRANTY ARE THE ONLY REMEDIES AVAILABLE TO ANY PERSON FOR BREACH OF THIS WARRANTY. HAMMERHEAD SHALL HAVE NO LIABILITY TO ANY PERSON FOR INCIDENTAL, CONSEQUENTIAL OR SPECIAL DAMAGES OF ANY DESCRIPTION, WHETHER ARISING OUT OF EXPRESS OR IMPLIED WARRANTY OR ANY OTHER CONTRACT, NEGLIGENCE OR OTHER TORT OR OTHERWISE. THIS EXCLUSION OF CONSEQUENTIAL, INCIDENTAL, AND SPECIAL DAMAGES IS INDEPENDENT FROM AND SHALL SURVIVE ANY FINDING THAT THE EXCLUSIVE REMEDY FAILED OF ITS ESSENTIAL PURPOSE.

ALL IMPLIED WARRANTIES (INCLUDING BUT NOT LIMITED TO ANY IMPLIED WARRANTIES OF MERCHANTABILITY AND FITNESS FOR A PARTICULAR PURPOSE) ARE LIMITED IN DURATION TO THE WARRANTY PERIOD DESCRIBED HEREIN. HAMMERHEAD DISCLAIMS ALL EXPRESS WARRANTIES NOT STATED IN THIS WARRANTY. Some states do not allow limitations on how long an implied warranty lasts, so the above limitation may not apply if it is inconsistent with the controlling state law.

This limited warranty excludes failures not caused by a defect in material or workmanship. This limited warranty does not cover damage due to accidents, abuse or improper handling, maintenance or use. This limited warranty also does not cover any engine that has been structurally altered, or when the vehicle has been used in racing competition. This limited warranty also does not cover physical damage, corrosion or defects caused by fire, explosions or other similar causes beyond the control of HAMMERHEAD.

Owners are responsible for performing the scheduled maintenance identified in the owner's manual. HAMMERHEAD may deny warranty claims for failures that have been caused by the owner's or operator's improper maintenance or use, by accidents for which HAMMERHEAD has no responsibility, or by acts of God.

WARRANTY

Any qualified repair shop or person may maintain, replace, or repair the emission control devices or systems on your vehicle. An authorized HAMMERHEAD dealer can perform any service that may be necessary for your vehicle. HAMMERHEAD also recommends HAMMERHEAD parts, however equivalent parts may be used for such service. It is a potential violation of the Clean Air Act if a part supplied by an aftermarket parts manufacturer reduces the effectiveness of the vehicle's emission controls. Tampering with emission controls is prohibited by federal law.

To receive information about how to make a warranty claim, how to make arrangements for authorized repairs, or if you are unable to obtain emission warranty service or are dissatisfied with warranty service received, please contact HAMMERHEAD for additional assistance.

Hammerhead Off-Road Inc.
1200 Lakeside Parkway #400
Flower Mound, TX 75028
Telephone: 214-513-1700 or toll-free 1-800-275-1701
Fax: 214-513-1711
Email: mail@hammerheadoffroad.com

OFF-ROAD WARRANTY REGISTRATION FORM**Registration Terms & Conditions**

In order to activate the warranty, please follow the instructions below:

1. Make a copy of the Bill of Sale.
2. Make a copy of Pre-Delivery Checklist.
3. Fill out warranty card and send with all above documents to:

Hammerhead Off-Road
Attn: Warranty Registration
1200 Lakeside Parkway Ste. 400
Flower Mound, TX 75028
Or, Fax to 214-513-1738

Or, go online to www.hammerheadoffroad.com under dealer's only section

HAMMERHEAD OFF-ROAD WARRANTY REGISTRATION CARD

(Must be sent in with a copy of sales receipt)

VIN#:

Model:

Dealer Name:

Dealer Address (Street / City / State / ZIP):

Customer Name:

Customer City and State:

Customer Phone / Email:

Date of Purchase:

I Certify that all information provided is true and correct to the best of my knowledge. I understand the exceptions and limitations of the warranty coverage.

Customer Signature:

Date:

MAINTENANCE LOG

MAINTENANCE LOG

Use the following chart to record periodic maintenance.

DATE	MILES (KM) OR HOURS	TECHNICIAN	SERVICE PERFORMED / COMMENTS

5-Point Seat Belt	24
-------------------------	----

A

Age Restrictions	12
Air Filter.....	61
Air Filter / Air Box.....	78
Auxiliary Outlet.....	27

B

Battery	72
Charging	74
Battery Installation	73
Battery Maintenance	79
Battery Removal.....	73
Battery Storage.....	74
Boots	11
Brake Fluid.....	65
Brake Inspection	64
Brake Pedal	28
Brake System Break-in	32
Brakes	64
Braking	35

C

Carburetor Jetting Chart.....	85
Carrying a Passenger.....	14
Carrying Multiple Passengers.....	14
Chrome Wheel Care	77
Clothing.....	11
Component Locations.....	23
Constant Variable Transmission (CVT) System	60
Crankcase Emission Control System	43
Crossing Hillsides	15
CVT Break-in (Clutches / Belt).....	32
CVT Drying	60

D

Drive Belt Wear / Burn	87
------------------------------	----

Drive Chain Lubrication.....	54
Drive Chain Slack Adjustment	54
Driver's Seat Adjustment.....	24
Driving Downhill	39
Driving Downhill Improperly	16
Driving in Reverse	40
Driving on a Sidehill (Sidehilling) ...	39
Driving on Slippery Surfaces	38
Driving Over Obstacles	41
Driving Through Water.....	40
Driving Uphill	38
Driving with a Passenger.....	36

E

Engine and Drivetrain Break-in	31
Engine Backfires	88
Engine Doesn't Turn Over	87
Engine Oil.....	78
Engine Runs Irregularly, Stalls or Misfires	89
Engine Stop Switch (LE Models Only)	26
Engine Stops or Loses Power	90
Engine Turns Over, Fails to Start... ..	88
Equipment Modifications	9
Exhaust Valve Clearance Adjustment	59
Exported Products	95
Exposure to Exhaust	19
Eye Protection	11

F

Failure to Inspect Before Operating	13
Fluid Change	53
Fluid Check	53
Fluid Levels.....	78
Fog the Engine	79
Front Wheel Hub Tightening	68
Fuel Cap.....	29
Fuel Filter	51

G

Gear Selector	27
Gloves	11
GTS150 Specifications	81, 83

H

Hammerhead Warning.....	6
Headlamp Replacement.....	70
Helmet	11
Horn	27
Hot Exhaust Systems	19
How To Obtain Warranty Service...	94

I

Ignition Switch (LE-Models Only) ..	25
Ignition Switch (Non-LE Models) ...	26
Improper Hill Climbing	16
Improper Tires and Maintenance... ..	18
Inspect and Lubricate	78
Intake Valve Clearance Adjustment	58

J

Jumps and Stunts	15
------------------------	----

L

Light Switch.....	26
Limitations Of Warranties And Remedies.....	92
Limited Warranty	91
Lubricants and Fluids	93
Lubrication Recommendations	49

M

Maintenance Chart Key	46
Maintenance Log.....	101
Mechanical Speed Control System	29

N

New Operator Driving Procedures.....	35
Noise Emission Control System	43
Normal Plug	57
Notice	95

O

Off-Road Warranty Registration Form	99
Oil Change.....	51
Oil Check.....	50
Oil Recommendations	50
Operating at Excessive Speeds	15
Operating Improperly in Reverse... ..	17
Operating in Unfamiliar Terrain	16
Operating on Frozen Bodies of Water	18
Operating on Pavement	14
Operating on Public Roads	14
Operating on Sand or Slippery Terrain	17
Operating Over Obstacles	17
Operating Through Water	18
Operating Without Instruction	12
Overloading the Vehicle	17

P

Parking Brake	28
Parking Brake Adjustment	55
Parking Brake Cable Freeplay Adjustment	56
Parking on an Incline	40
Parking the Vehicle	35
Periodic Maintenance Chart.....	45
Physical Control of the Vehicle	15
Polishing the Vehicle	77
Pre-Ride Inspection	32
Protective Apparel	14

R

Racing-Style Seat Belt (if equipped)	25
Refueling	19
Registration	92
Removal from Storage	79
Rider Height	13

S

Safe Operation Practices	33
Safe Riding Gear	10
Safety Labels and Locations	20
Safety Symbols	5
Safety Warnings	12
Seat Belt Inspection	25
Seat Belts	13, 24
Severe Use Definition	45
Shock Spring Adjustment	67
Signal Words	5
Spark Plug Gap / Torque	57
Spark Plug Removal and Replacement	58
Stabilize the Fuel	78
Stalling While Climbing a Hill	16
Starting the Engine	34
Steering Wheel	24
Steering Wheel Inspection	65
Stop Engine Button (Non-LE Models)	27
Stopping the Engine	34
Storage Area / Covers	79
Storage Tips	78

T

Tail Light Lamp Replacement	70
Throttle Freeplay	62
Throttle Freeplay Adjustment	63
Throttle Freeplay Inspection	62
Throttle Pedal	28
Throttle System	62
Tire Tread Depth	67
Tires	67
Toe Alignment	66

Transmission (Main Gearcase)	53
Transporting the Vehicle	80
Turning Improperly	15

U

U.S.A. EPA Emissions Limited Warranty	96
Unauthorized Use of the Vehicle ...	19

V

Valve Adjustment Procedure	58
Vehicle Break-in Period	31
Vehicle Identification Numbers	7
Vehicle Immersion	70

W

Warning Symbols	5
Washing the Vehicle	76
Wet Fouled Spark Plug	57
Wheel Nut Torque Specifications ...	68
Wheel Replacement	69